

# A brief history of ICP & ICP/MS Nebulizers

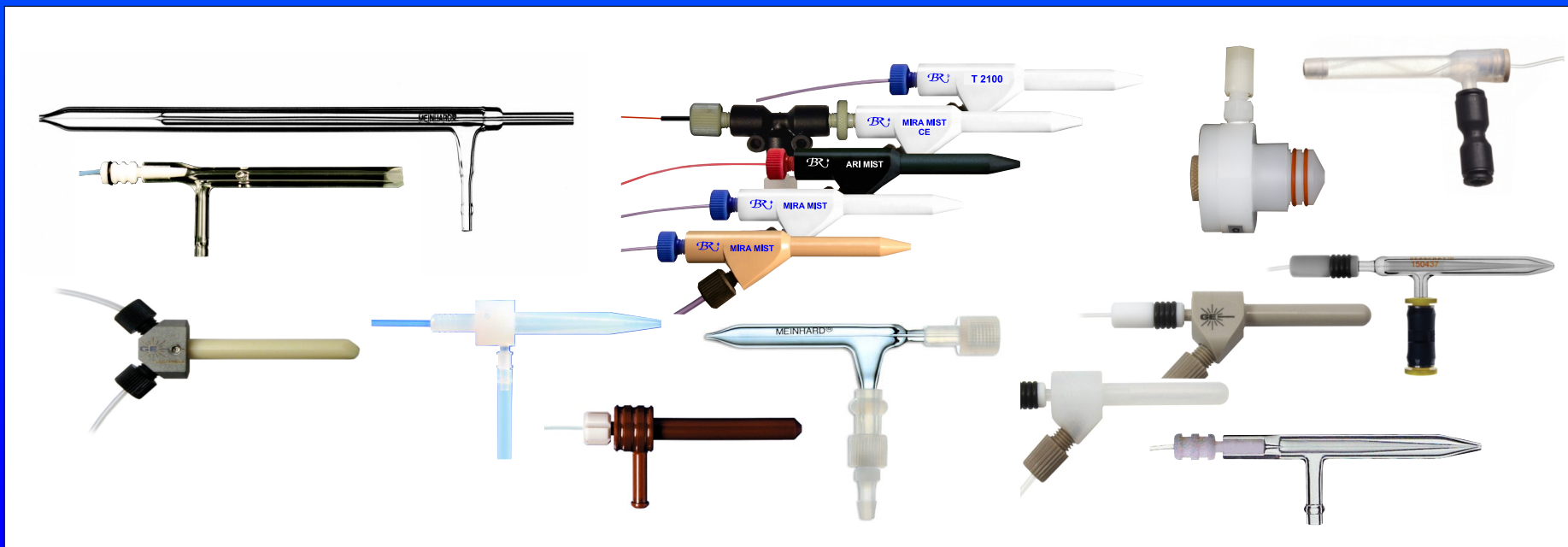

Presented by John A. Burgener

**Pneumatic nebulizers  
have always been,  
and are still  
the main  
sample introduction method  
for ICP and ICP/MS.**

**John A. Burgener**

 *Burgener Research Inc.*

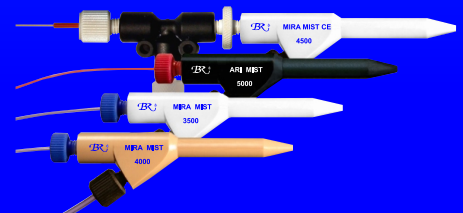

# In the beginning, there was the “Adjustable Cross Flow”

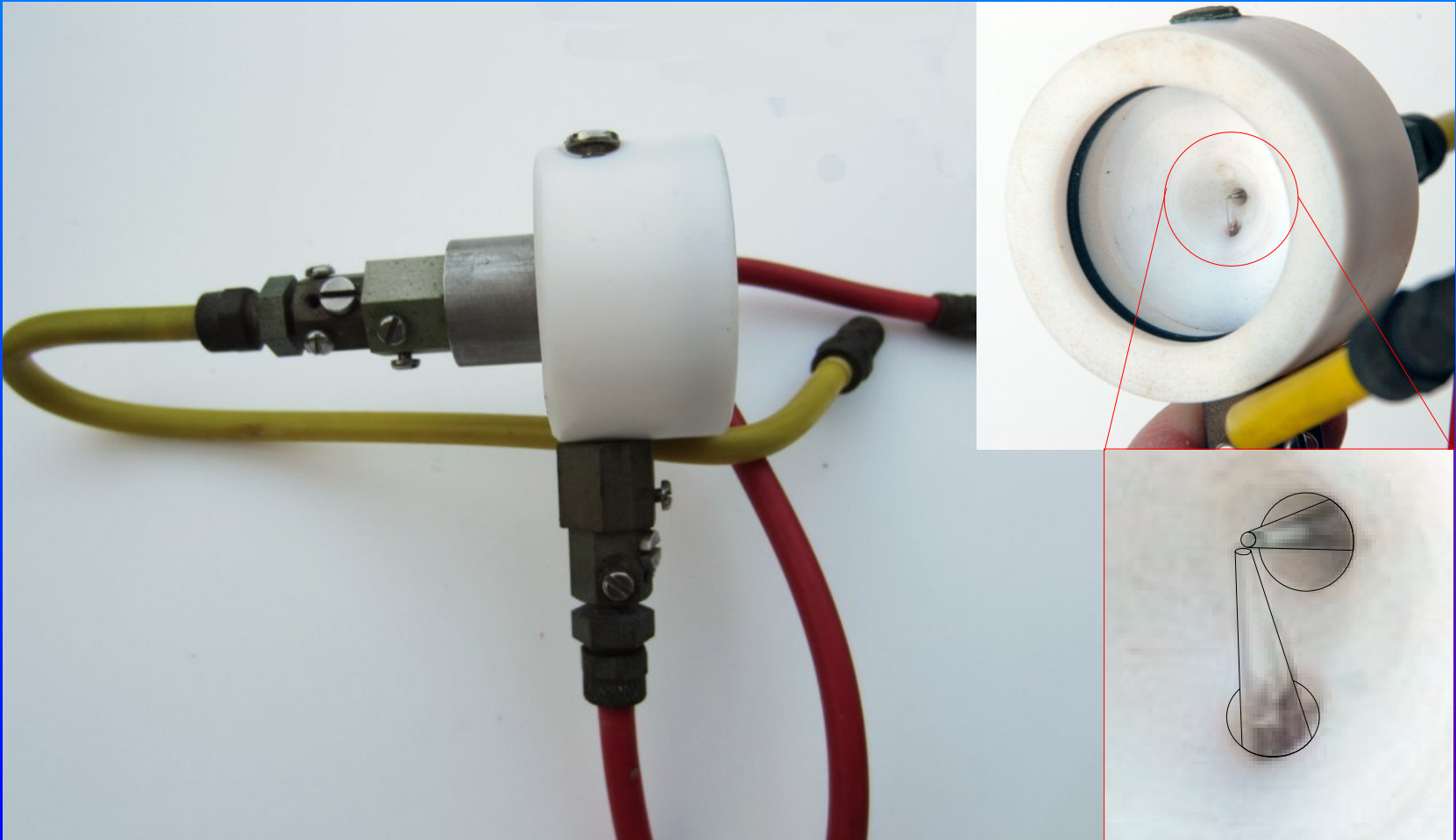

*They were difficult to adjust, easily broken  
and easily plugged from salting or particles.*

John A. Burgener

 Burgener Research Inc.

# This was soon followed by the Meinhard Concentric, 1974



Meinhard Type T nebulizer  
Serial # 4250  
Made approx. 1978

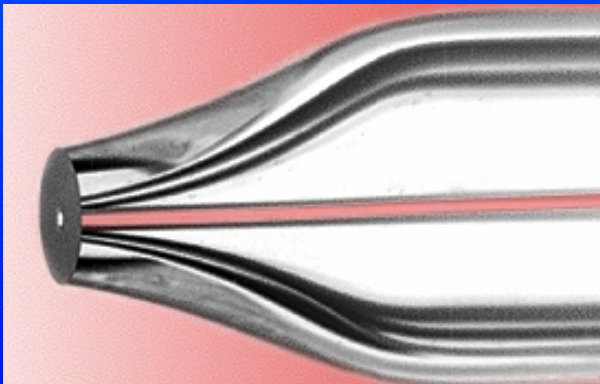

*Simple, elegant design.  
Similar to modern Concentrics.  
But salted and plugged easily.*

John A. Burgener

 Burgener Research Inc.



**1947: My father started Technical Service Laboratories**

**1974: TSL received the second ICP made by JA  
an Atom comp 950 - Arc/Spark instrument  
with an ICP source replacing the arc spark box.**

**1977: I was asked by my father to help get the ICP running.  
The objective was to run Whole Rock analysis.  
Whole Rock solutions were 3% LiBO4  
ALL nebulizers salted in hours or minutes.  
The Adjustable Cross Flow was the first one we used.  
Meinhard's concentric salted too fast - minutes.  
The cross flow salted in hours,  
and plugged too easily.**

# Induction pulls liquid into gas stream.

Low pressure beside gas stream causes liquids to vaporize leaving dissolved salts behind, causing salt deposits that plug gas orifices.

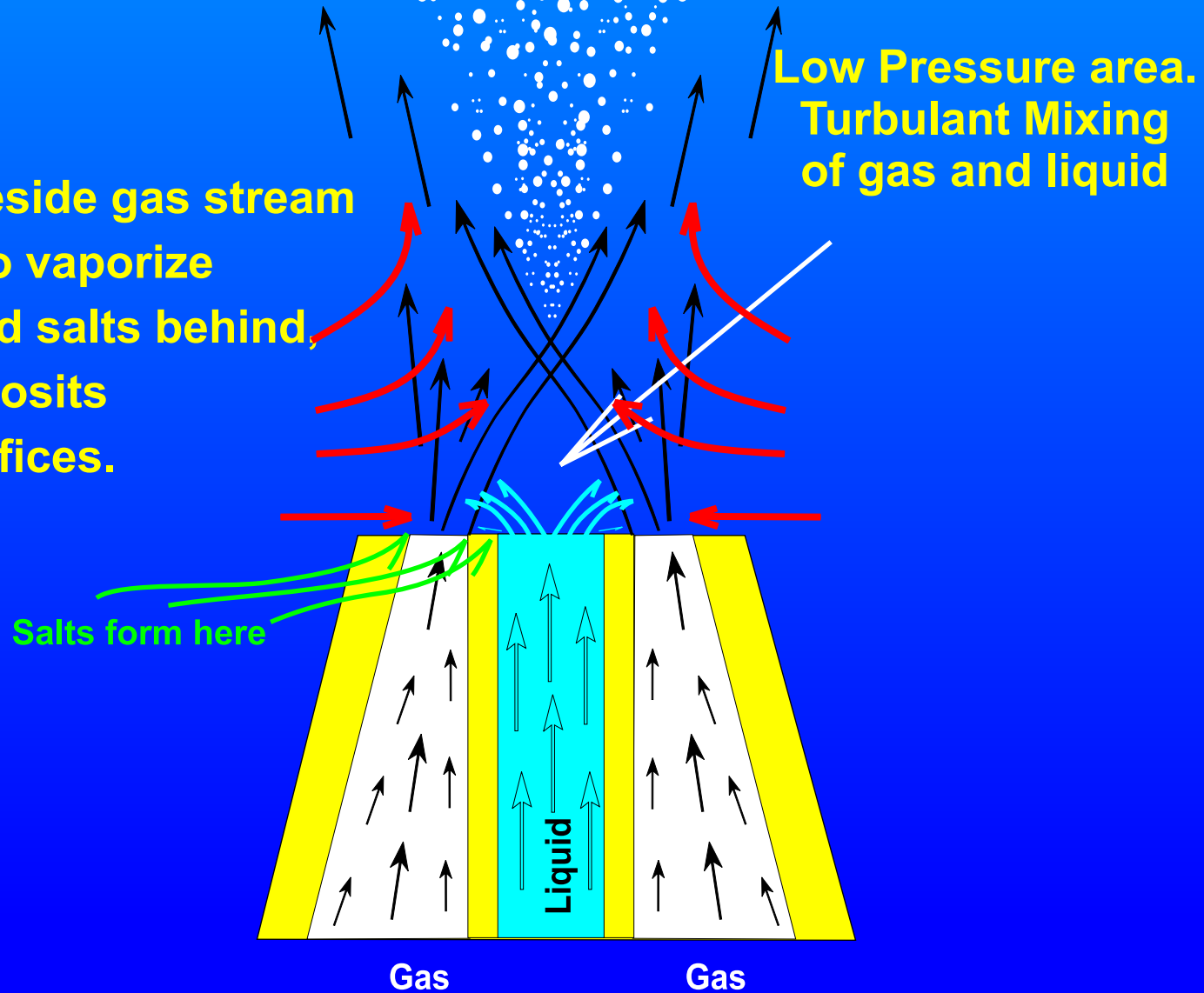

# Concentrics and Cross flows plug easily. To minimize plugging, Babington designs were developed.

Jan. 14, 1969

R. S. BABINGTON ETAL

3,421,692

METHOD OF ATOMIZING LIQUIDS IN A MONO-DISPERSED SPRAY

Filed Dec. 29, 1966

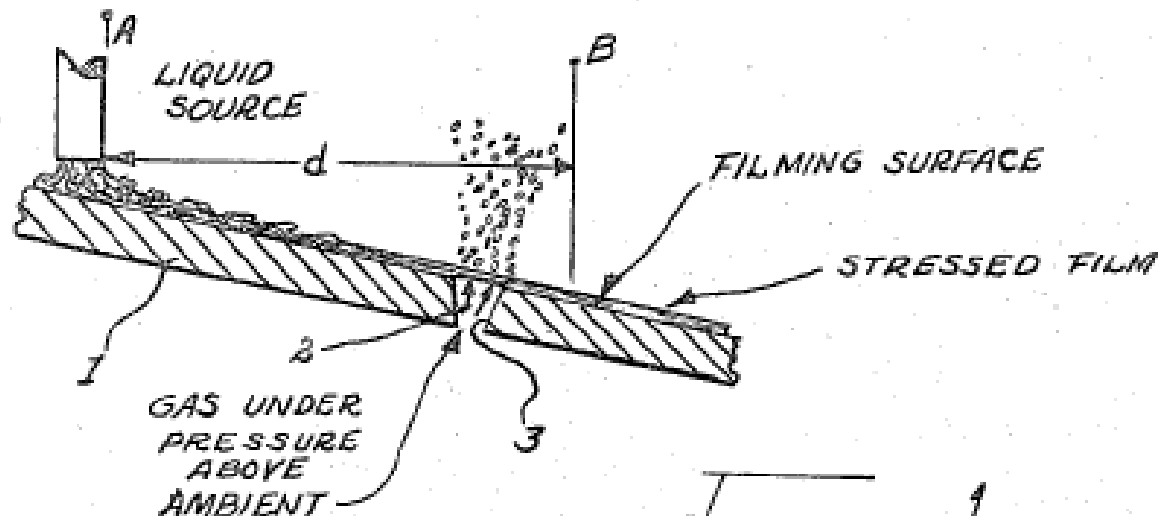

John A. Burgener

 Burgener Research Inc.

**High Solids resistant, but very inefficient.  
Only a little part of the liquid passed near the orifice.**

# 1978 Babington V Groove by Suddendorf and Boyer

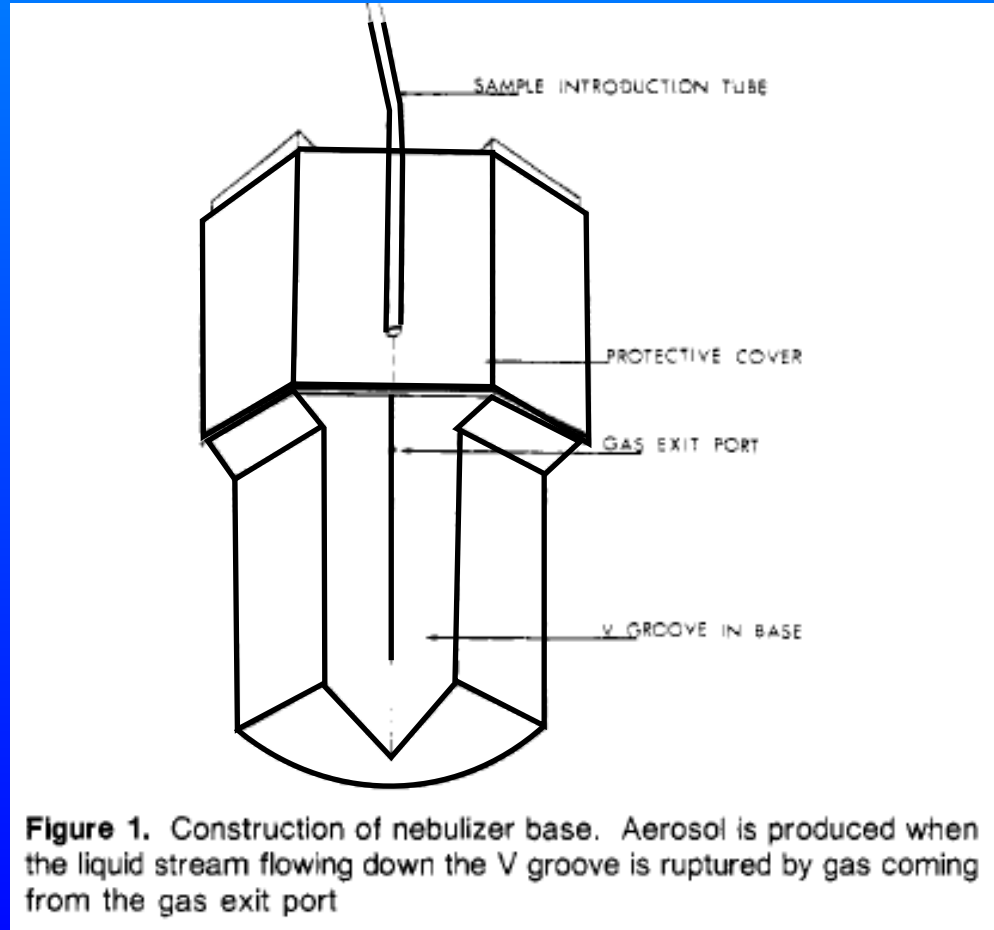

# 1980 Babington Pillar and Post by Garbarino and Taylor

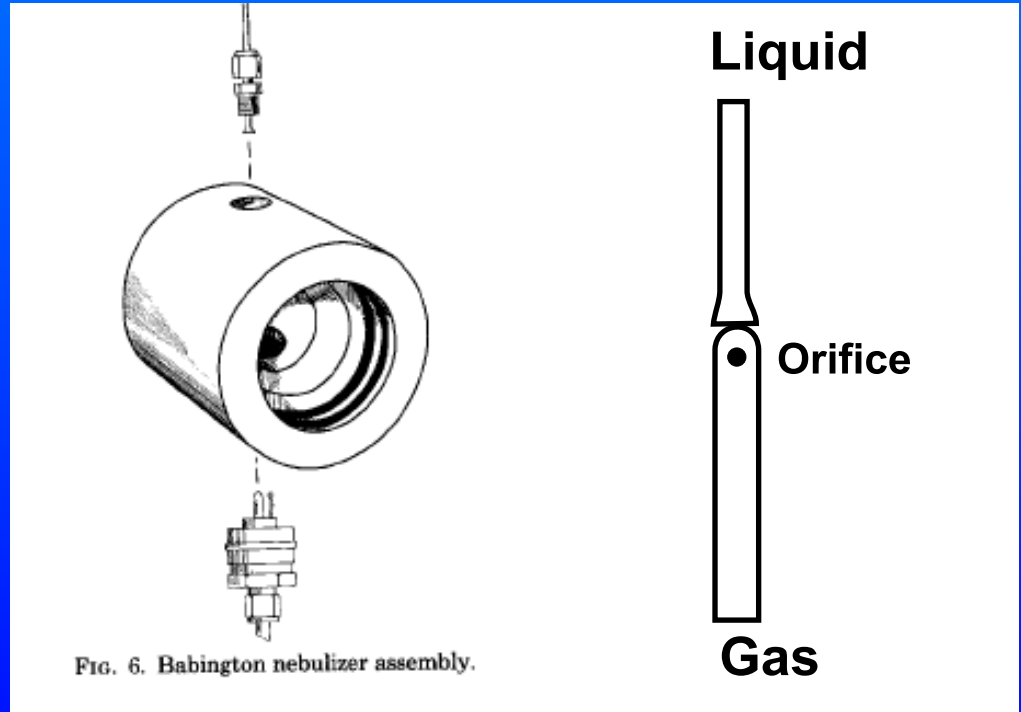

**High Solids resistant, but very inefficient.  
Only a little part of the liquid passed near the orifice.**

John A. Burgener

 Burgener Research Inc.

# ~ 1982 GMK Nebulizer Glass Babington V Groove

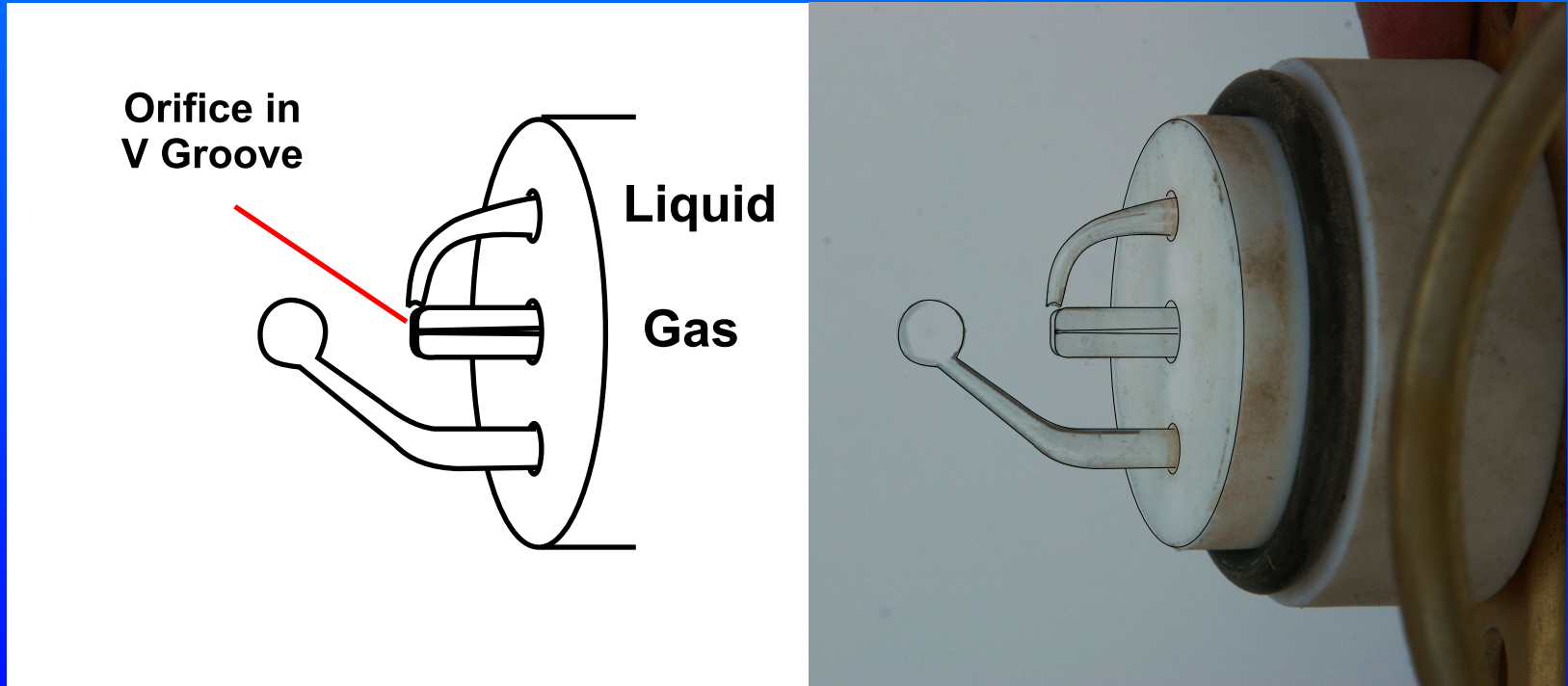

**Handled particles well, but  
gas orifice plugged if running high salts.**

John A. Burgener

 Burgener Research Inc.

# 1982 - Meddings' MAK Nebulizer A Fixed Cross Flow.

Significant improvement over previous ones.

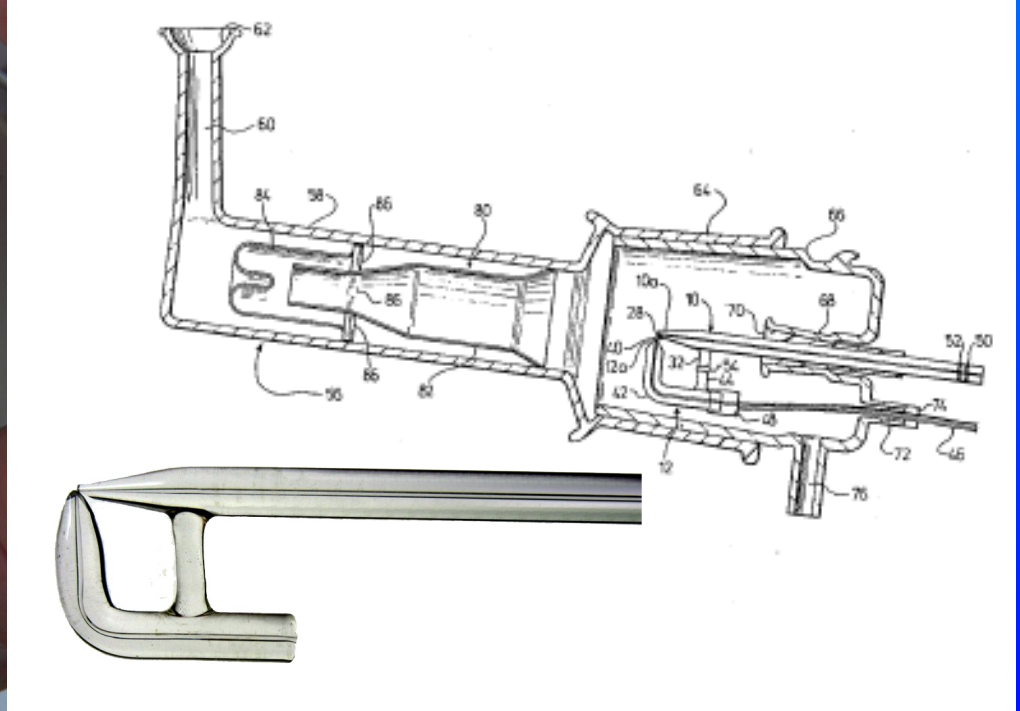

Handled high salts better than most.  
More stable, no adjustments.  
But still easy to plug with particles.

John A. Burgener

 Burgener Research Inc.

# 1983 Meinhard introduces the C Type Nebulizer

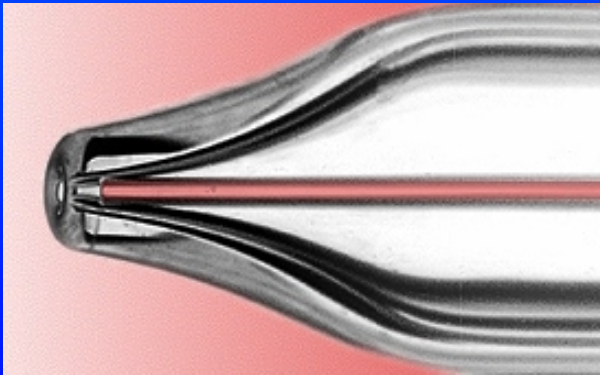

**Lapped edges reduced salting,  
but still salted on our solutions.**

John A. Burgener

 Burgener Research Inc.



# 1983 Precision Glassblowing began making glassware and nebulizers



**Similar to Meinhard's A Type  
and still salted on our solutions.**

John A. Burgener

 *Burgener Research Inc.*

# ~ 1983 Jarrell Ash (Thermo) Sapphire V Groove Nebulizer

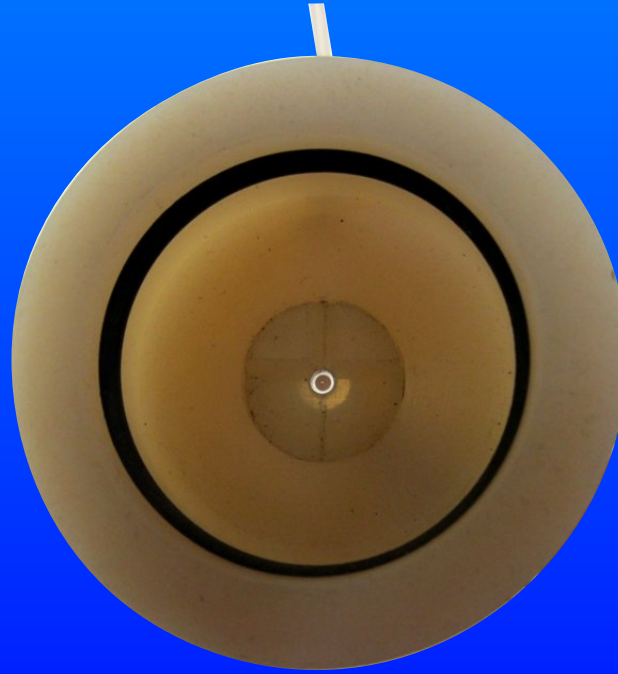

**Handled particles well, but  
Sapphire gas orifice would still salt rapidly.  
And Sapphire bead would often fall out.**

John A. Burgener

**BR** Burgener Research Inc.

# 1984 Meinhard introduces the K Type Nebulizer

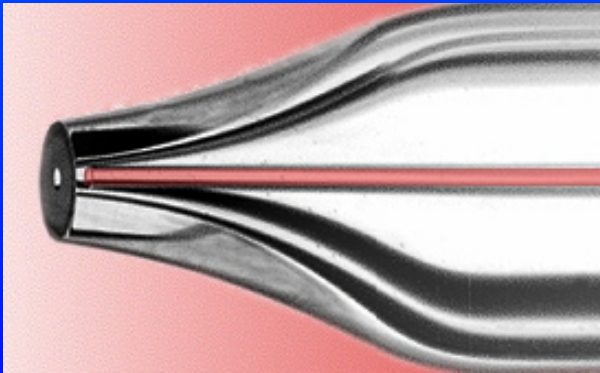

**Recessed inner capillary significantly reduced salting, but still salted on our solutions.**

John A. Burgener

 Burgener Research Inc.

# ~1984 Glass Expansion began making ICP glassware

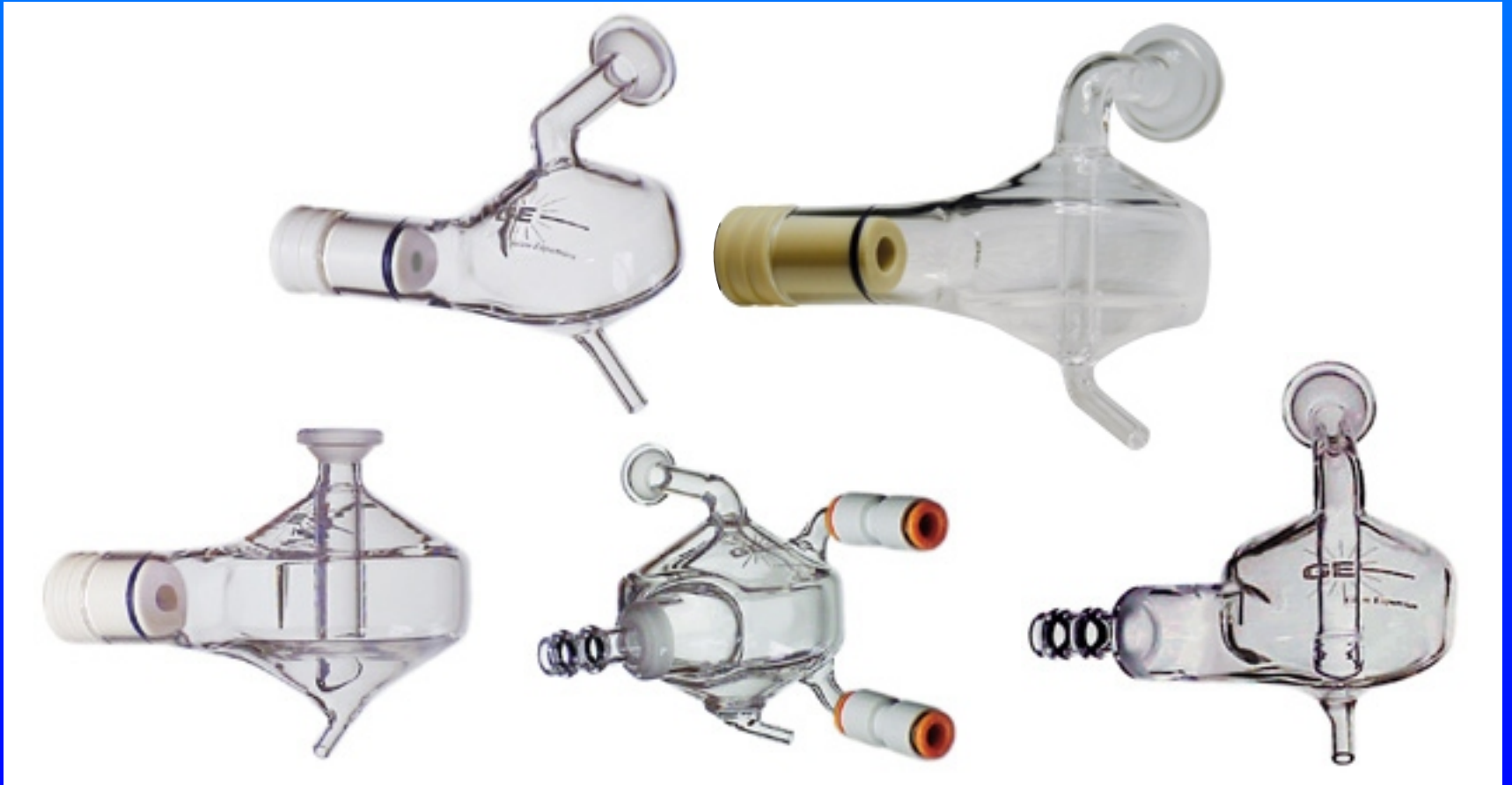

John A. Burgener

 Burgener Research Inc.

# 1984-85 The Burgener - Legere Nebulizer

First commercial Teflon Nebulizer.  
V Groove with no adjustable parts.



Handled high salts,  
More stable, no adjustments,  
Not plugged with particles.  
Very difficult to make - about a week each.  
**RAN FOR MONTHS WITHOUT SALTING!**

John A. Burgener

**BR** Burgener Research Inc.

# 1986 Fassel, Rice, Lawrence: MicroNebulizer for Direct Injection (US Patent # 4,575,609)

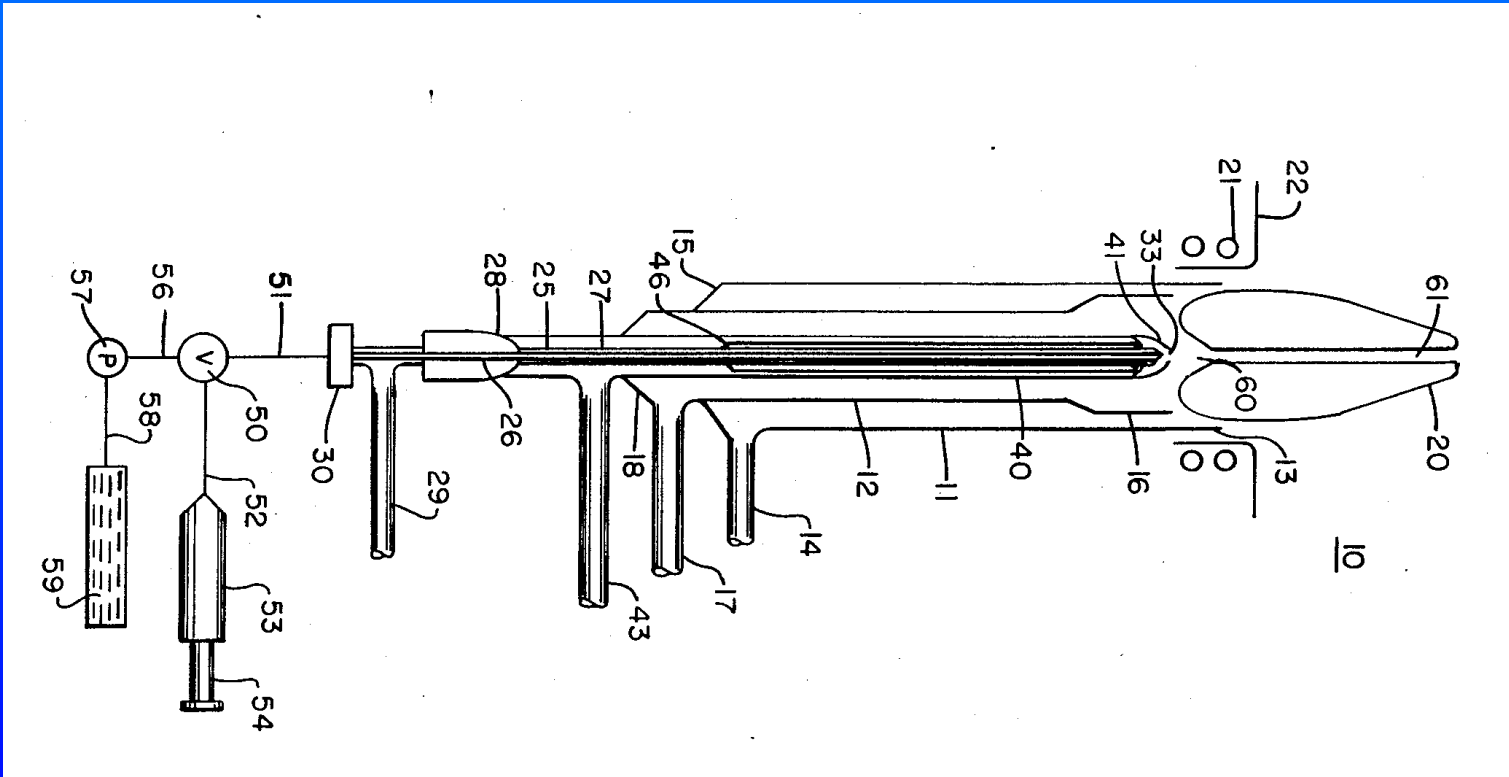

One of the first micro-nebulizers  
could not handle salts  
was not useful for most samples.

John A. Burgener

 Burgener Research Inc.

# 1986 Hildebrand Grid Nebulizer

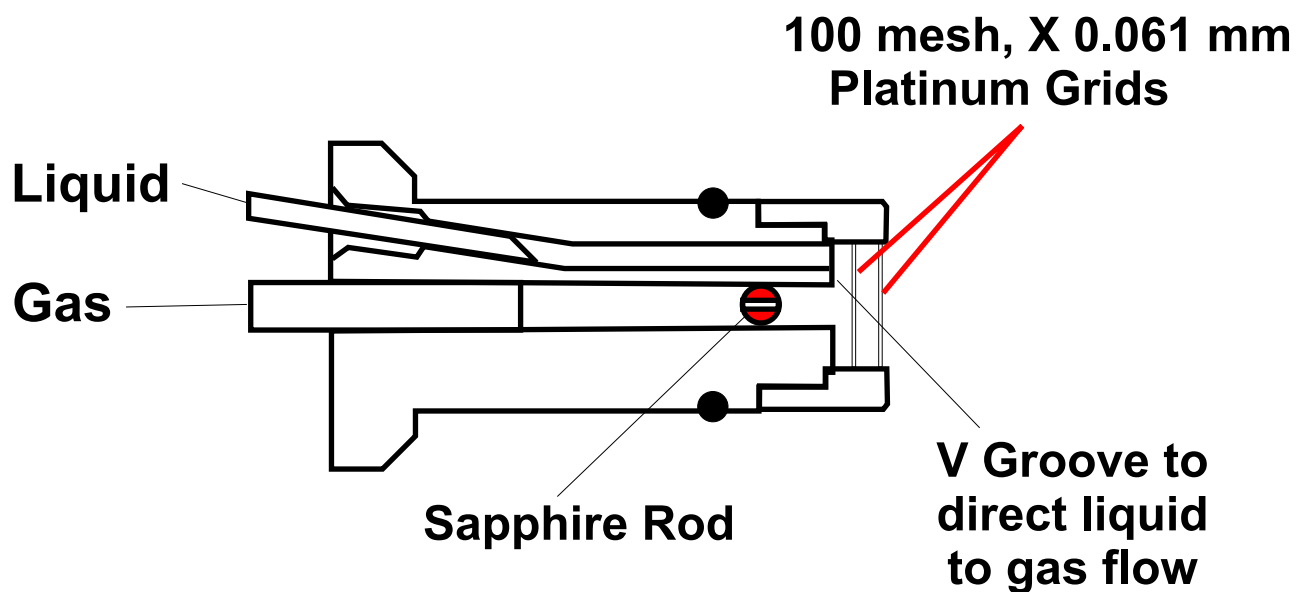

**Excellent Sensitivity**  
**Difficult to clean**  
**Long washout times**

# Late 1980s or early 1990s Perkin Elmer Gem Tip Cross flow

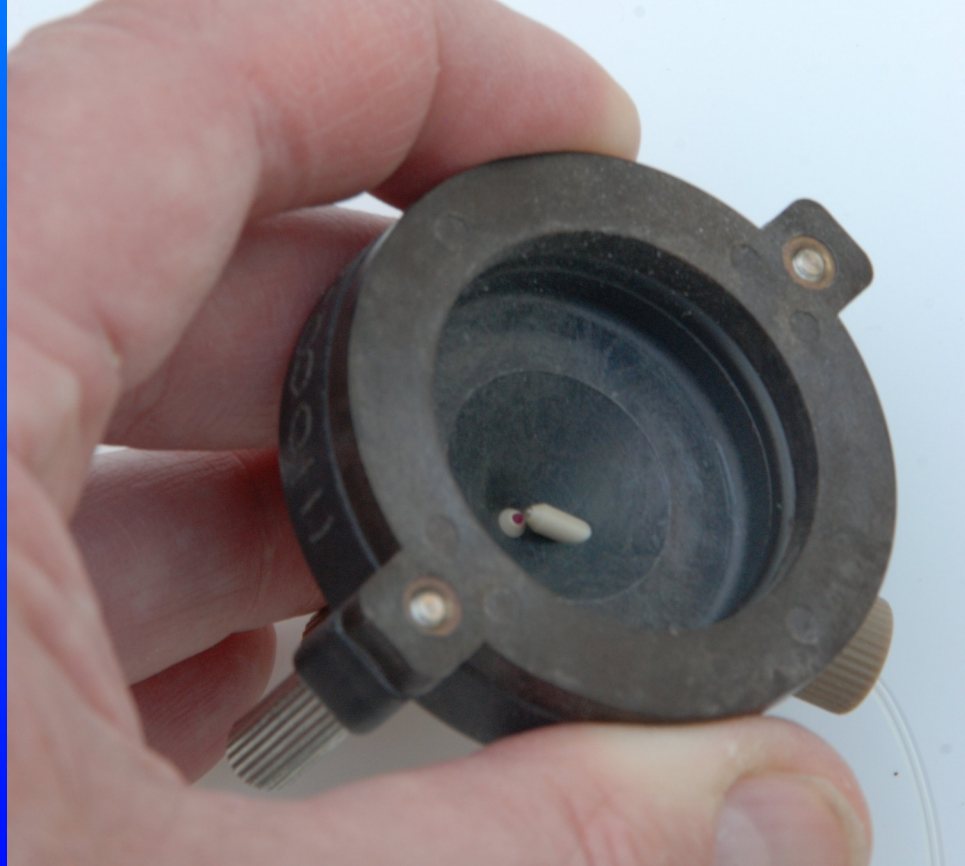

Excellent general purpose nebulizer for the analysis of strong mineral acids (including HF) and samples with less than 5% dissolved solids.  
Up to 20% NaCl can be aspirated by the nebulizer for 1 hour without clogging.  
Uses chemically resistant GemTips made of sapphire and ruby in a Ryton end cap for maximum resistance.



# 1988 CETAC Ultrasonic Nebulizers

## USN 5000, 6000

Efficiency approaches 30%, Sensitivity improves ~10x  
Droplet size < 5 microns.  
Potentially heavy solvent load so Desolvation essential.  
Peltier cooling essential.  
Membrane separator available and usually essential.  
Desolvation interferences occur (eg., As III vs. As IV)

Does not handle high solids well.  
Long washout times required due to desolvators.

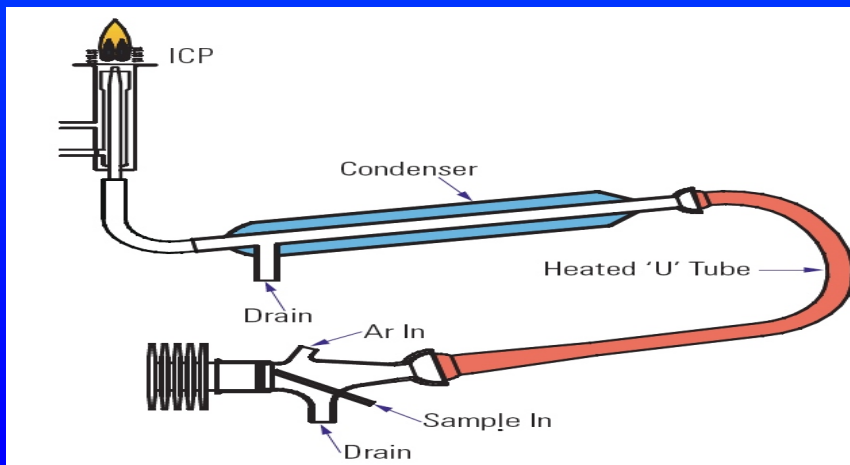

Evaluation of an Ultrasonic Nebulizer Using Perkin-Elmer Sequential ICP Instrumentation - Robert Thomas, Cindy Anderau - Atomic Spectroscopy, 10 (2), 71 (1989). This paper describes the capabilities of the first commercially available ultrasonic nebulizer, the CETAC USN-5000 with two of Perkin Elmer's ICP optical emission spectrometers, the Plasma 40 and Plasma II. Various criteria were evaluated including detection limit, precision and memory test. The conclusion of the work was that the early design of this product showed great promise but required some improvements to be accepted and used as a truly routine analytical tool.

# Late 1980s: Cyclonic Chambers Arrive

The early chambers were variations on AA chambers.  
Most were large straight tubes with baffles.  
The Scott Double Pass became the most successful of these.  
Most nebulizers were designed to fit 35 mm OD front ends of chambers.

In the late 1980s cyclonic chambers became popular.  
introduced by Glass Expansion

With 2X the sensitivity, and 1/2 the washout time,  
most labs switched to cyclonic chambers.

At first, only concentrics fit.

So nebulizers were re-designed to fit the GE standard 6mm  
cyclonic chamber nebulizer fittings.

# 1987 Glass Expansion's first Nebulizer: The VeeSpray a ceramic V groove Nebulizer

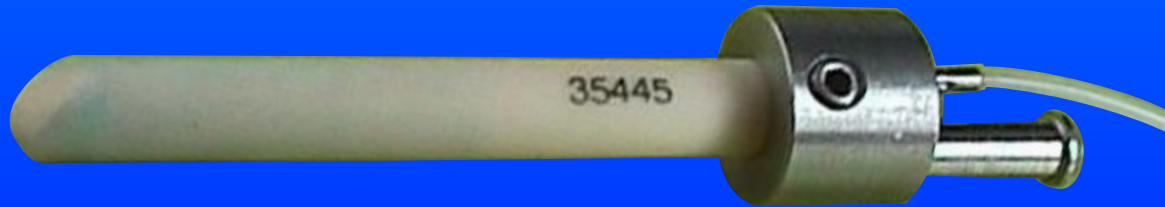

Material: alumina ceramic  
High TDS tolerance: typically up to 30%  
High tolerance to particulates: typically up to 300  $\mu$  m  
Must be pumped - does not self aspirate  
Operates best between 1.5 and 2.5mL/min

John A. Burgener

 Burgener Research Inc.

# 1989 Glass Expansion's first Concentric The Conikal



**Machined inner capillary  
instead of glass blown.**

John A. Burgener

 Burgener Research Inc.

# 1989 Noordermeer Glass V Groove

Sample

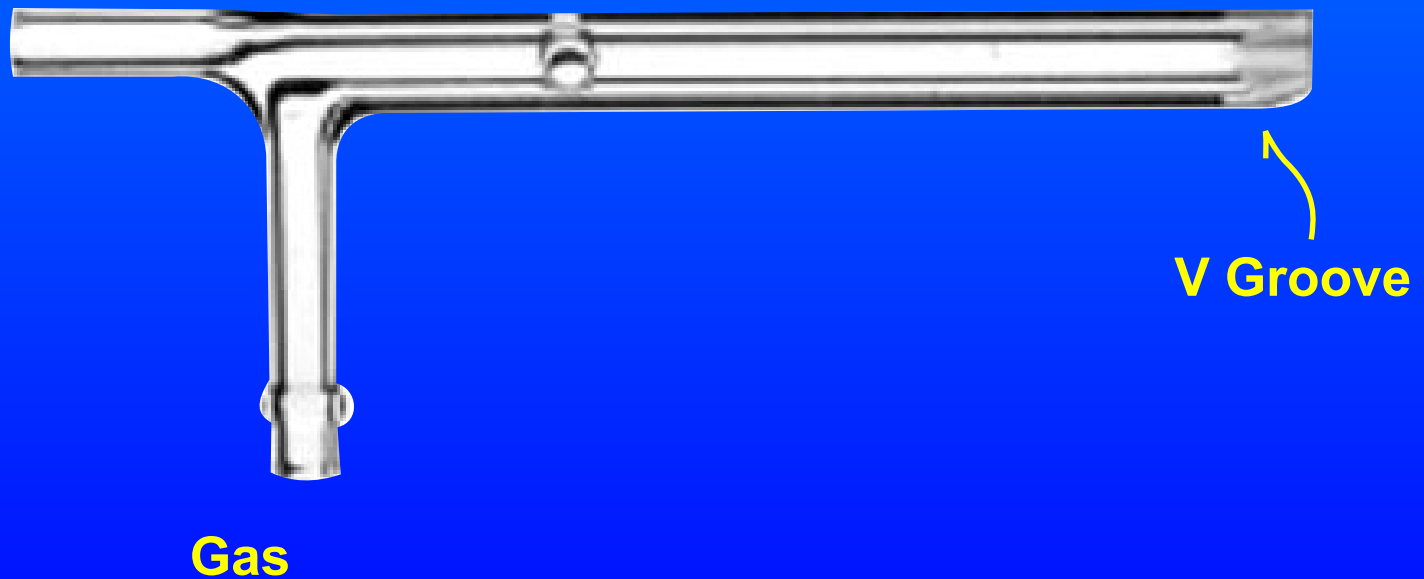

**Good to Excellent Sensitivity  
Orifice can salt.**

John A. Burgener

 Burgener Research Inc.

# 1992 Glass Expansion began making the non salting Sea Spray

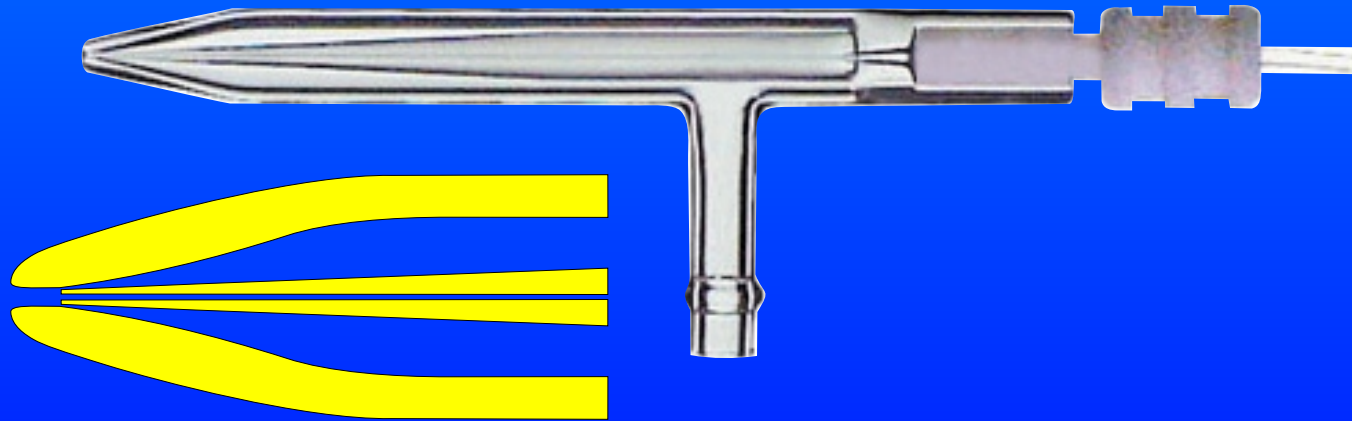

**Tip of inner capillary is recessed more than with Meinhard K  
Nose body extended to create a self cleaning area inside the tip  
Can handle 20% salts without blocking  
Had improved sample line attachment for easy fitting  
and minimal dead volume.**

John A. Burgener

 Burgener Research Inc.

# 1993 Modified Lichte Glass V Groove

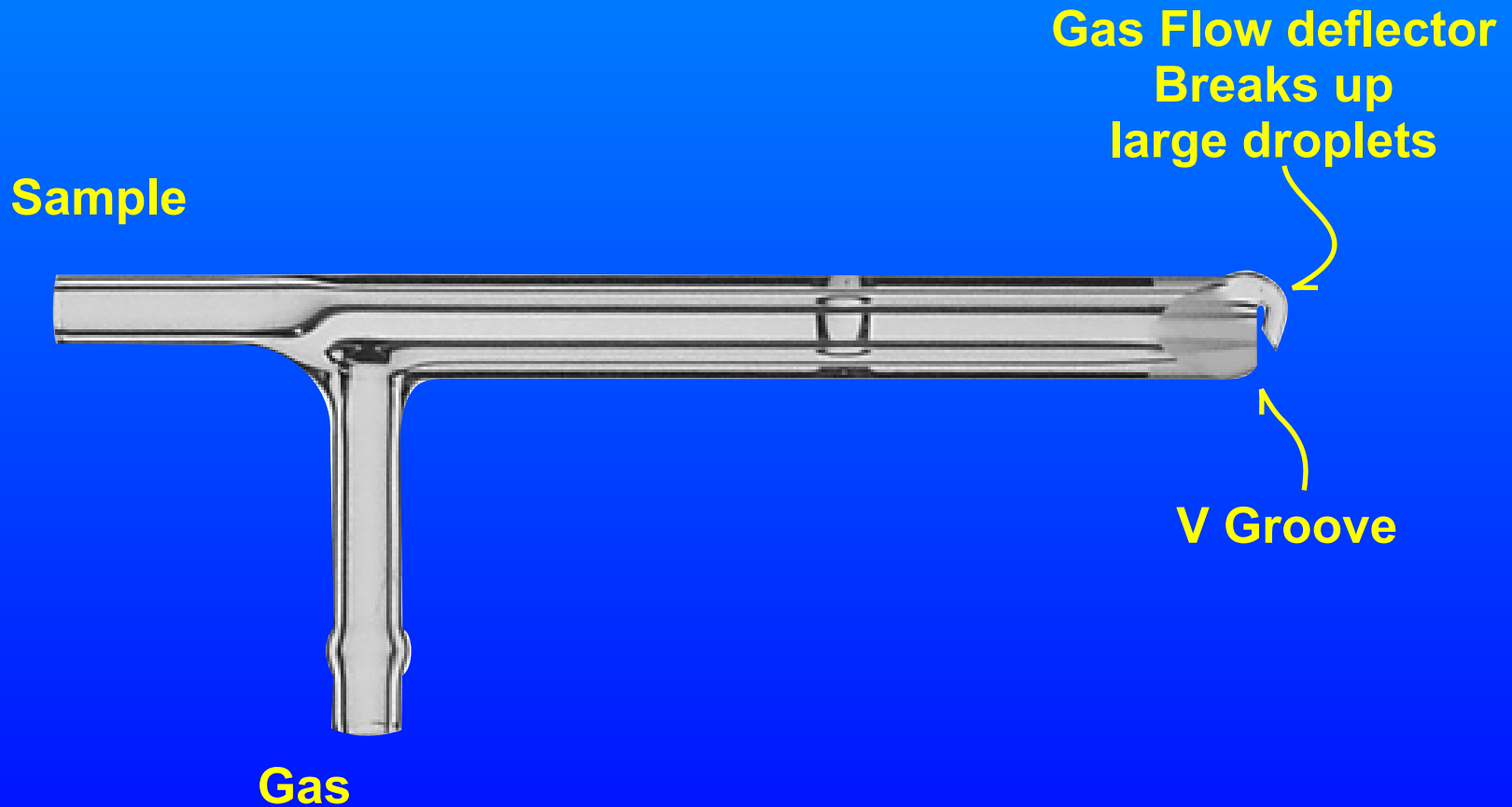

**Good to Excellent Sensitivity**  
**Orifice can salt.**  
**Overloads many ICP torches.**

# 1993 BTF - The first Burgener Parallel Path

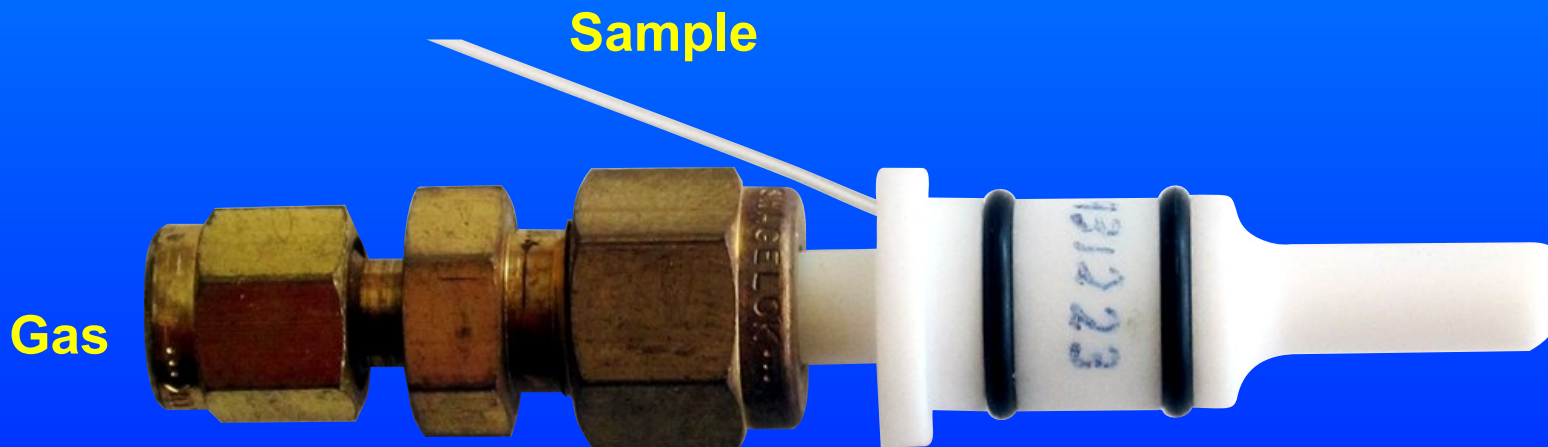

**Good to Excellent Sensitivity**

**Non salting design:**

**can run 100% saturated solutions.**

**Lasts for months without washing.**

**Difficult to make - about 2 days each.**

**Not as sensitive as a concentric.**

John A. Burgener

 *Burgener Research Inc.*



# The Main Burgener Parallel Path Nebulizers 1994 - 1995

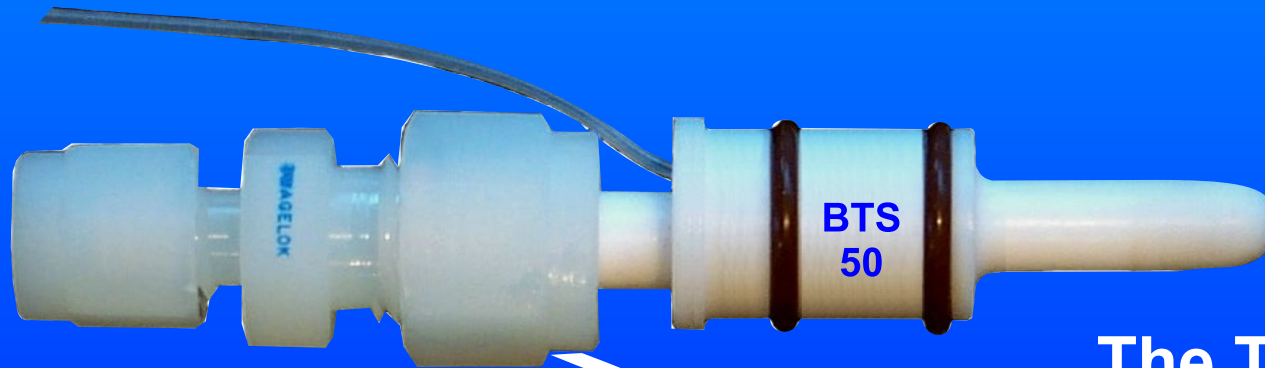

The BTS 50



The Thermo Trace

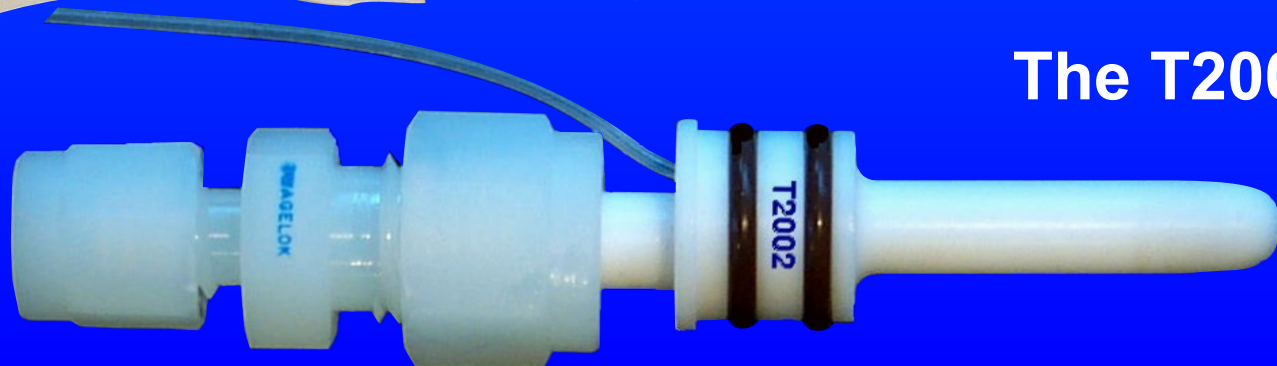

The T2002

**Less Difficult to make - about 1 day each.  
Eventually we reduced it to about 4 hours each.**

# Mid 1990s: Perkin Elmer Miniature V Groove The Gem Cone

Last V groove design I am aware of



John A. Burgener

 Burgener Research Inc.

# V groove designs still commercially available:

As of 2013

**Glass Expansion VeeSpray**

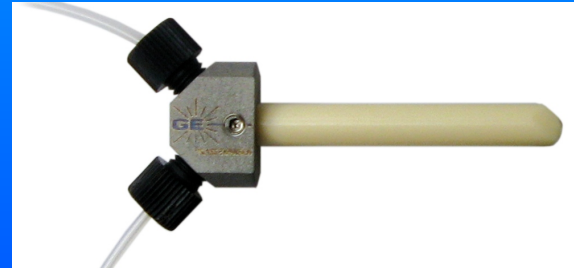

**Perkin Elmer Gemcone**



**Precision Glassblowing  
Modified Lichte**

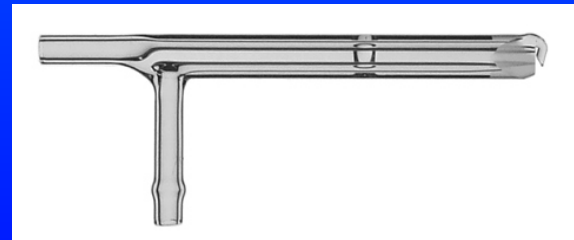

**Precision Glassblowing  
Noordermeer**

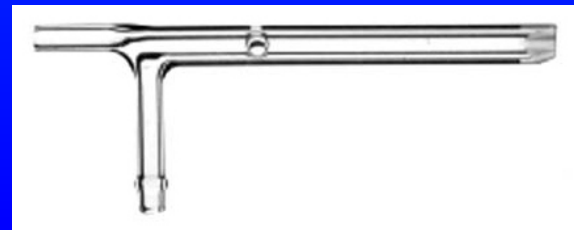

**They all suffer from salting, and are no longer significant in the market. They have generally been replaced by newer, better designs.**

# Cross Flow nebulizers also declined in use.

Partly in response to the cyclonic chambers.

They are not as good as concentrics in sensitivity and stability.

They are less easy to salt and plug as a concentric, but it is still easy.

But they are inexpensive to make.

So most manufacturers have at least one model available.

And some new ones have been introduced in the last 10 years:

**SavilleX: X-Flow  
PFA Cross Flow Nebulizer**



**SCP: Ultem Mini Cross Flow  
designed for cyclonic chambers**



John A. Burgener

 Burgener Research Inc.

# The arrival of the ICP / MS

In the late 1980s and early 1990s,  
ICP / MS became useful lab instruments.

Previously they were mainly used by  
R&D institutions and universities.

With Agilent and Perkin Elmer / Sciex  
ICP /MS became common instruments by the mid 1990s.

Nebulizers running 2 ml/min sent too much sample to the Mass Spec.

Concentrics were able to run much lower flow rates,  
and still provide excellent stability and sensitivity.

The development of micro nebulizers began.

# MEINHARD HEN: High Efficiency Nebulizer ~ 1993

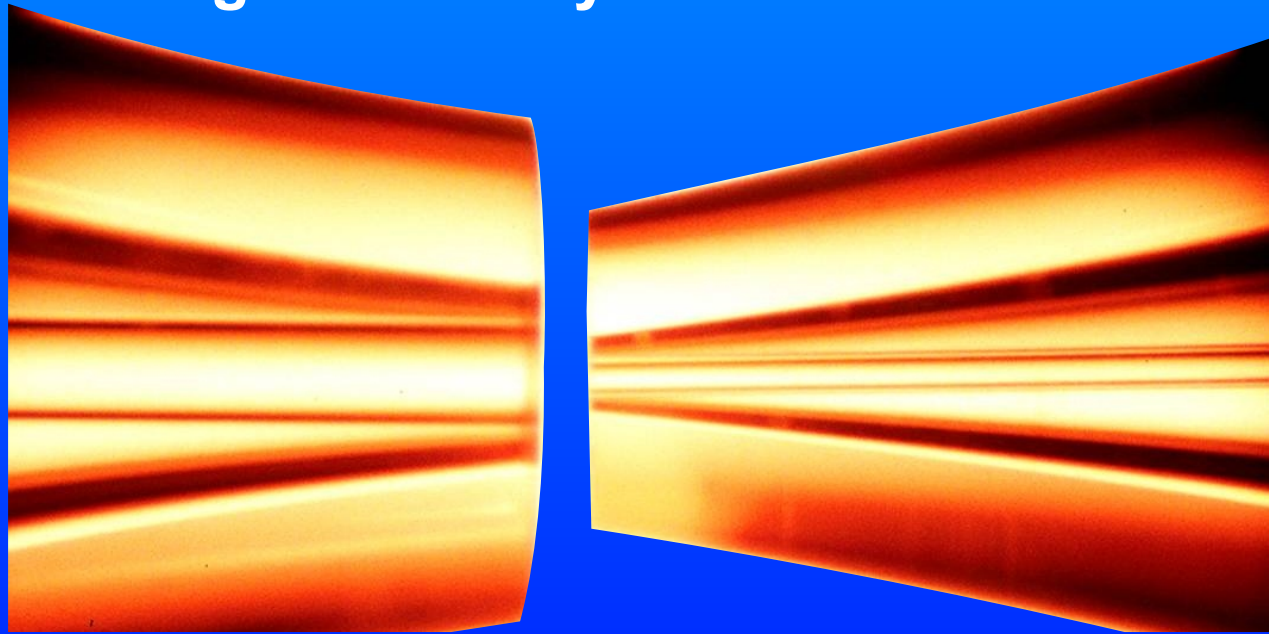

	TR-30	HEN-170
Sample Capillary:	220-320 $\mu\text{m}$	70-110 $\mu\text{m}$
Gas orifice ID:	350-450 $\mu\text{m}$	150-200 $\mu\text{m}$
Pressure at 1 L/min:	25-40 psi	150-180 psi
Normal operating pressure:	15-25 psi	25-60 psi

**Very Low Flow capable**  
**Very easily plugged and salted**

# Burgener Nebulizers Showed the advantages of Teflon

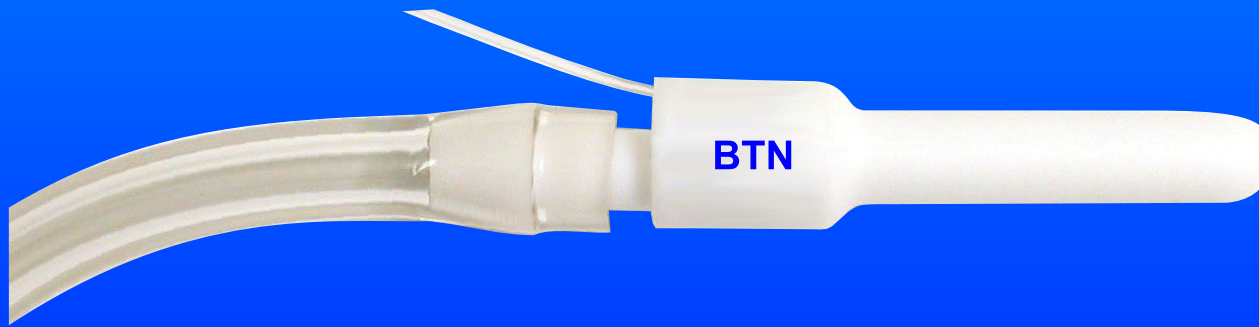

**The Non Salting nature of Teflon Gas Orifices  
was desirable in all designs.**

# 1997 Cetac Microconcentric Nebulizer

The MCN 100 was probably the first Teflon Concentric.  
It was also the first non-Burgener Nebulizer  
commercially available that was 100% Teflon.



**MCN 100 and Aspire**  
**50, 100, 200, or 400  $\mu$ L/min**

John A. Burgener

 Burgener Research Inc.



# 1997 Direct Injection High Efficiency Nebulizer Meinhard's DIHEN

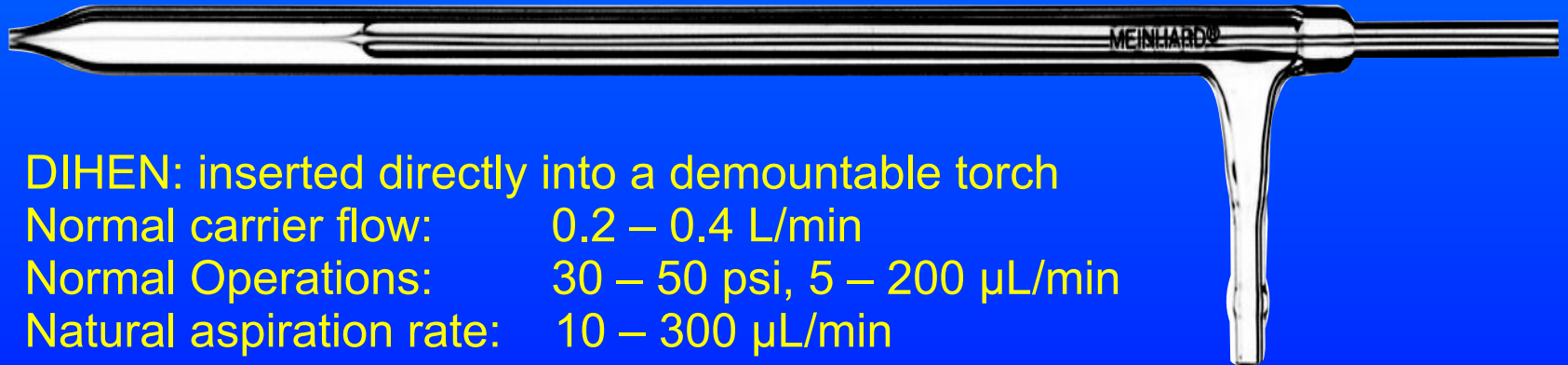

DIHEN: inserted directly into a demountable torch

Normal carrier flow: 0.2 – 0.4 L/min

Normal Operations: 30 – 50 psi, 5 – 200  $\mu$ L/min

Natural aspiration rate: 10 – 300  $\mu$ L/min

Minimizes speciation interferences

Easily introduce highly volatile solvents

Essentially 100% transport

Design and test pressure: 90, 120, 150, or 170 psi @ 1 L/min

John A. Burgener

 Burgener Research Inc.

A. Montaser, J. A. McLean, and Jerold M. Kacsir,  
A Novel Direct Injection High Efficiency Nebulizer for Atomic Spectroscopy, 1997  
Patent Applications filed December 28, 1998  
U.S. Patent No. 6,166,379, December 26, 2000.

# 1997 Direct Injection High Efficiency Nebulizer Meinhard's DIHEN



**Good Concept,  
But droplets do not have time to vaporize.  
droplets arrive in plasma as droplets.**

**Other designs will provide greater sensitivity and stability  
by NOT being close to the plasma.**

John A. Burgener

 *Burgener Research Inc.*

A. Montaser, J. A. McLean, and Jerold M. Kacsir,  
A Novel Direct Injection High Efficiency Nebulizer for Atomic Spectroscopy, 1997  
Patent Applications filed December 28, 1998  
U.S. Patent No. 6,166,379, December 26, 2000.

Note: 1997 - J E Meinhard Produces the 50,000th Nebulizer!

# 1999 Elemental Sciences introduced their PFA Concentric Nebulizers

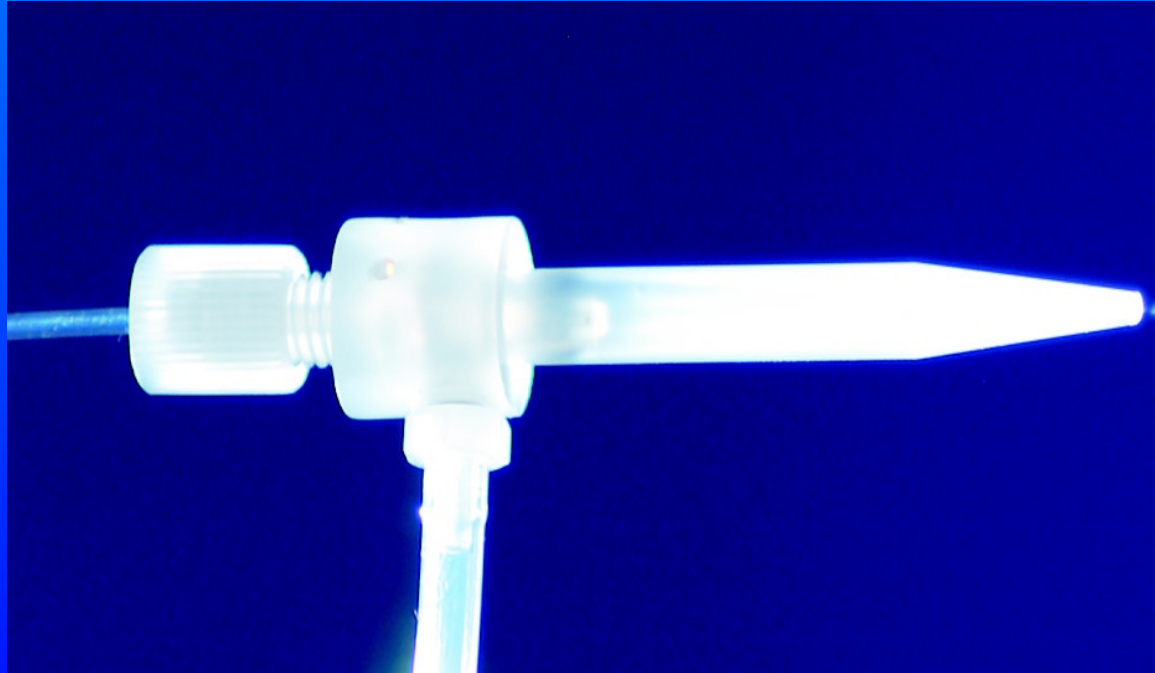

**20, 50, 100, or 400  $\mu\text{L}/\text{min}$**

John A. Burgener

 Burgener Research Inc.

# 1999 Burgener Introduces the Micro 1

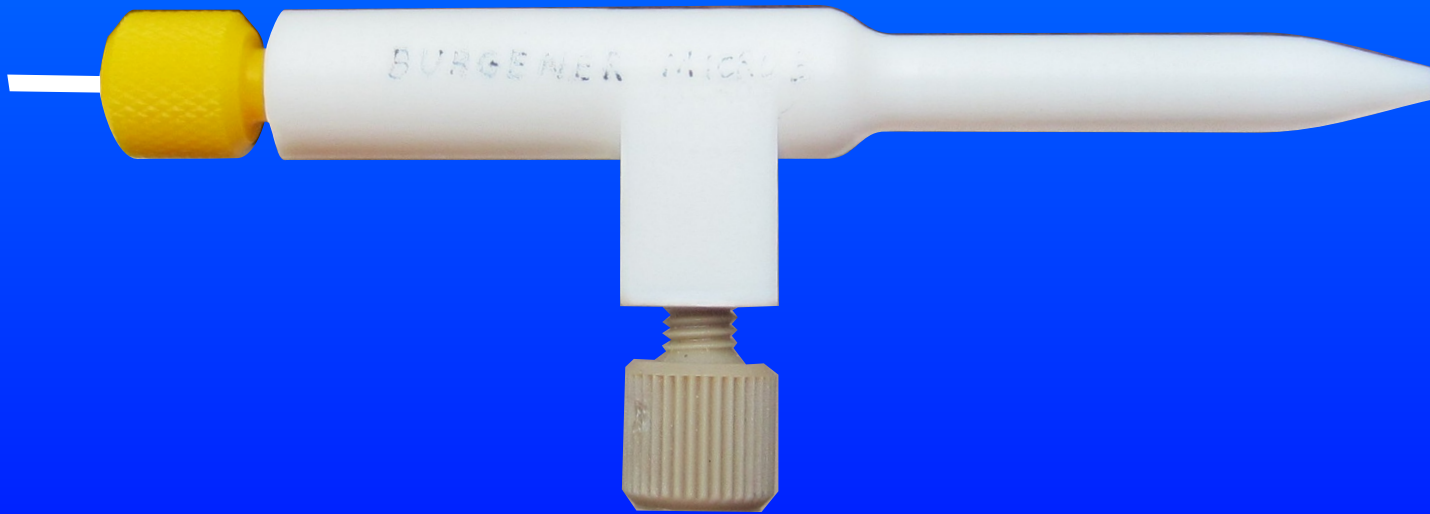

**Designed to run low flows, 50 to 1,500  $\mu$ l/min  
New method of construction - New body design.  
Still based on the original Parallel Path method.**

John A. Burgener

 Burgener Research Inc.



# What's New in Nebulizers

## PART 2: Since the year 2000

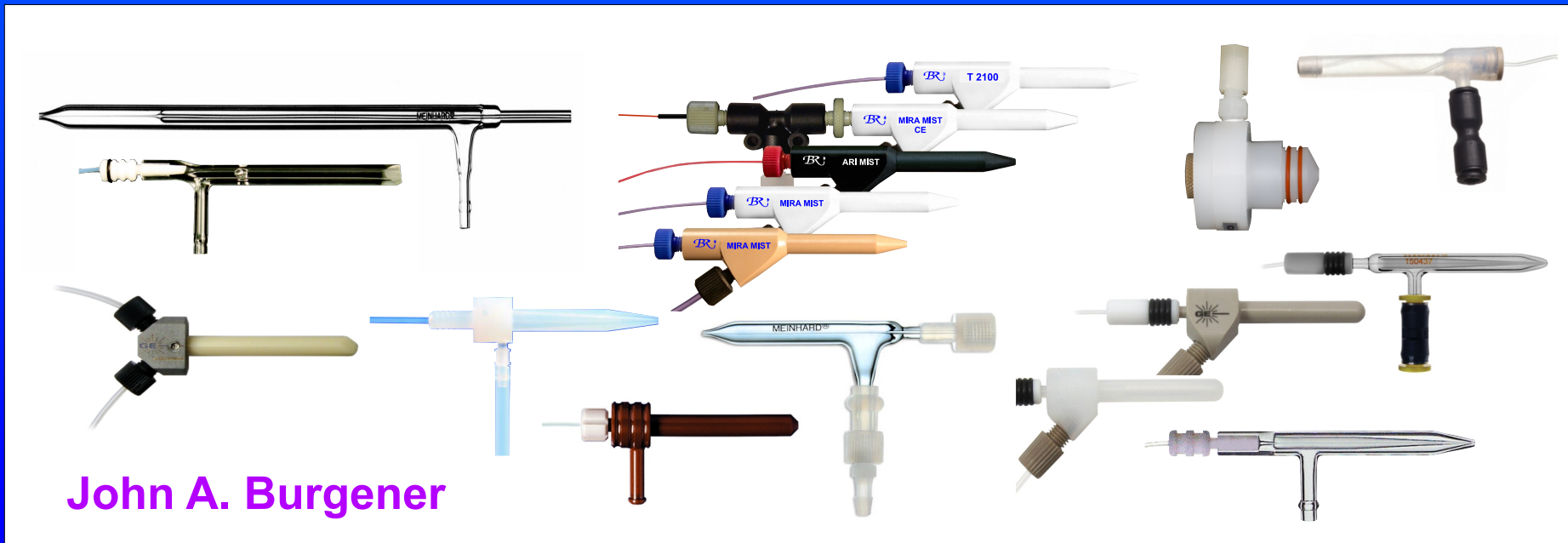

# 2000 Burgener Micro 3



Improved Body design over Micro 1,  
still original Parallel Path Method  
Still aiming at low flow  
50 - 1500 ul/min range  
Looks like a Mira Mist but very different.

John A. Burgener

 Burgener Research Inc.

# More changes in PFA Concentrics then in Glass Concentrics

**Elemental Scientific:** Many models including micro PFA nebulizers  
**Glass Expansion:** Opal Mist Nebulizer  
**Cetac:** Aspire, MCN 100 Micro Concentrics  
**Savillex:** C Flow

**Many micro designs, and standard flows  
But nothing essentially unique or exciting since 2000**

**Models range from a few microliters/minute to about 1 ml/min**

# ESI produces many variations on PFA Neb.

## PFA MicroFlow Nebulizers

PFA-20	20-35 $\mu\text{L}/\text{min}$
PFA-50	45-65 $\mu\text{L}/\text{min}$
PFA-75	65-96 $\mu\text{L}/\text{min}$
PFA-100	90-150 $\mu\text{L}/\text{min}$
PFA-200	150-250 $\mu\text{L}/\text{min}$
PFA-400	300-400 $\mu\text{L}/\text{min}$

## PFA-ST Nebulizers

0.15 mm i.d.	20 $\mu\text{L}/\text{min}$
0.20 mm i.d.	50 $\mu\text{L}/\text{min}$
0.25 mm i.d.	100 $\mu\text{L}/\text{min}$
- pumped	0.1 to 1.0mL/min
0.30 mm i.d.	200 $\mu\text{L}/\text{min}$
0.50 mm i.d.	400 $\mu\text{L}/\text{min}$
- pumped	0.5 to 3.0mL/min
0.80 mm i.d.	700 $\mu\text{L}/\text{min}$

PFA-HS: High dissolved solids, 300 $\mu\text{m}$  ID

PFA-LS: laser ablation applications, 20 $\mu\text{L}/\text{min}$   
produces an aerosol at low gas flow rates:  
0.2—0.3 L/min

PFA-LC: HPLC Interface for micro and standard flow  
Low internal volume, 150 $\mu\text{m}$  ID

PFA-Q: internal quartz capillary,  
for applications where the analyte  
has memory issues with plastic  
such as Iodine

## PolyPro-ST Nebulizers

0.15 mm i.d.	20 $\mu\text{L}/\text{min}$
0.20 mm i.d.	50 $\mu\text{L}/\text{min}$
0.25 mm i.d.	100 $\mu\text{L}/\text{min}$
- pumped	0.1 to 1.0mL/min
0.30 mm i.d.	200 $\mu\text{L}/\text{min}$
0.50 mm i.d.	400 $\mu\text{L}/\text{min}$
- pumped	0.5 to 3.0mL/min
0.80 mm i.d.	700 $\mu\text{L}/\text{min}$
- pumped	up to 5.0mL/min

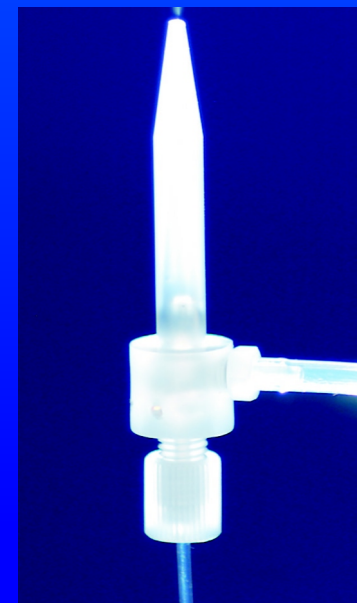



# 2012 Glass Expansion changes Opal Mist

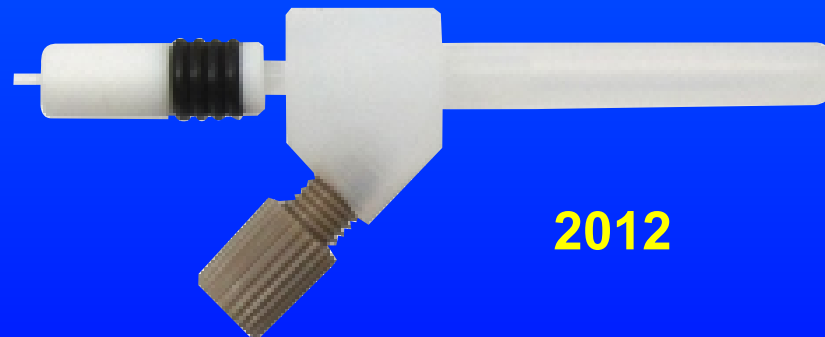
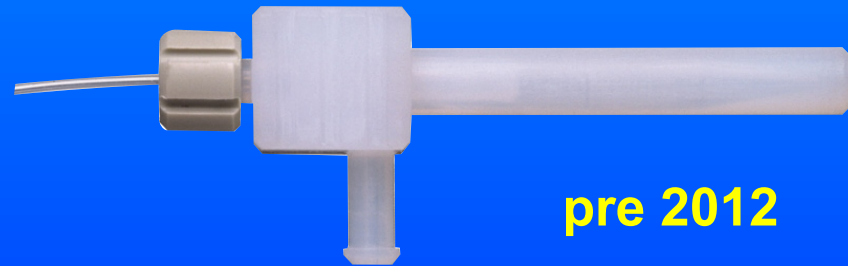

**Better sample line attachment**  
**More secure gas line attachment**  
**Less contaminating gas line attachment**

John A. Burgener

 Burgener Research Inc.

# 2005 Savillex C-Flow and X-Flow

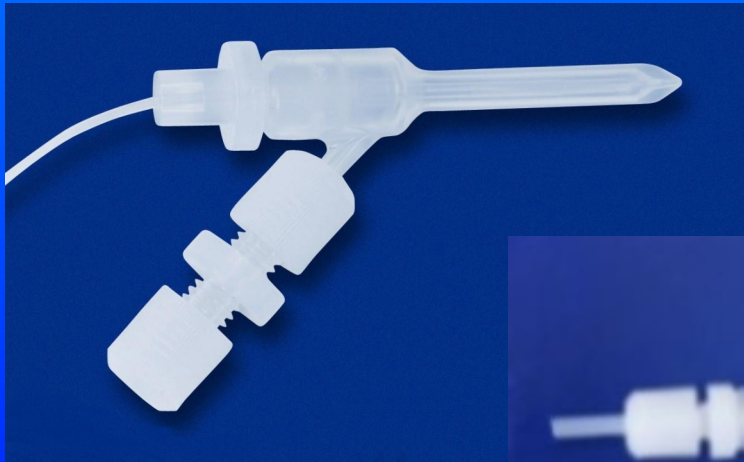

John A. Burgener

 Burgener Research Inc.

# Refinements in Glass Concentrics

Most manufacturers have continuously improved their designs

John A. Burgener

 Burgener Research Inc.

# 1980 & 90s Meinhard Concentric

Back end was much larger than inside central capillary.  
Led to plugging inside capillary,  
And poor sample line connections.

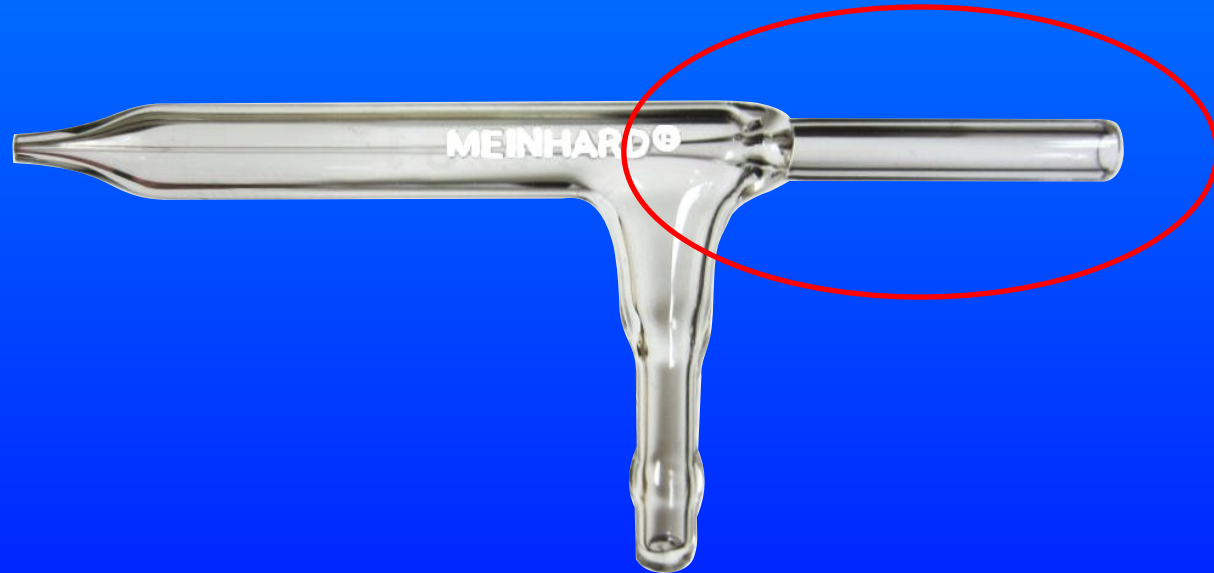

John A. Burgener

 Burgener Research Inc.

# 1980 & 90s Meinhard Concentric

Sample line was pressed into place  
Held partly by suction of nebulizer  
and partly by the capillary sticking in place  
and partly by luck.



Gas lines were Tygon tubing pushed over the barb.  
they regularly popped off if the pressure was 40+ psi

# Modern Meinhard Concentric

Back end is only a bit larger than inside central capillary.  
Minimizes plugging inside capillary.  
New Sample line fittings:  
Secure, easy to attach to LC or pump.



New Gas lines are connected  
with PFA fittings.  
Tight fit - no lines popping off.  
Non contaminating.

John A. Burgener

 Burgener Research Inc.

# MEINHARD®

## Comparison of Trace Metals Leached from Nebulizer Gas Fitting

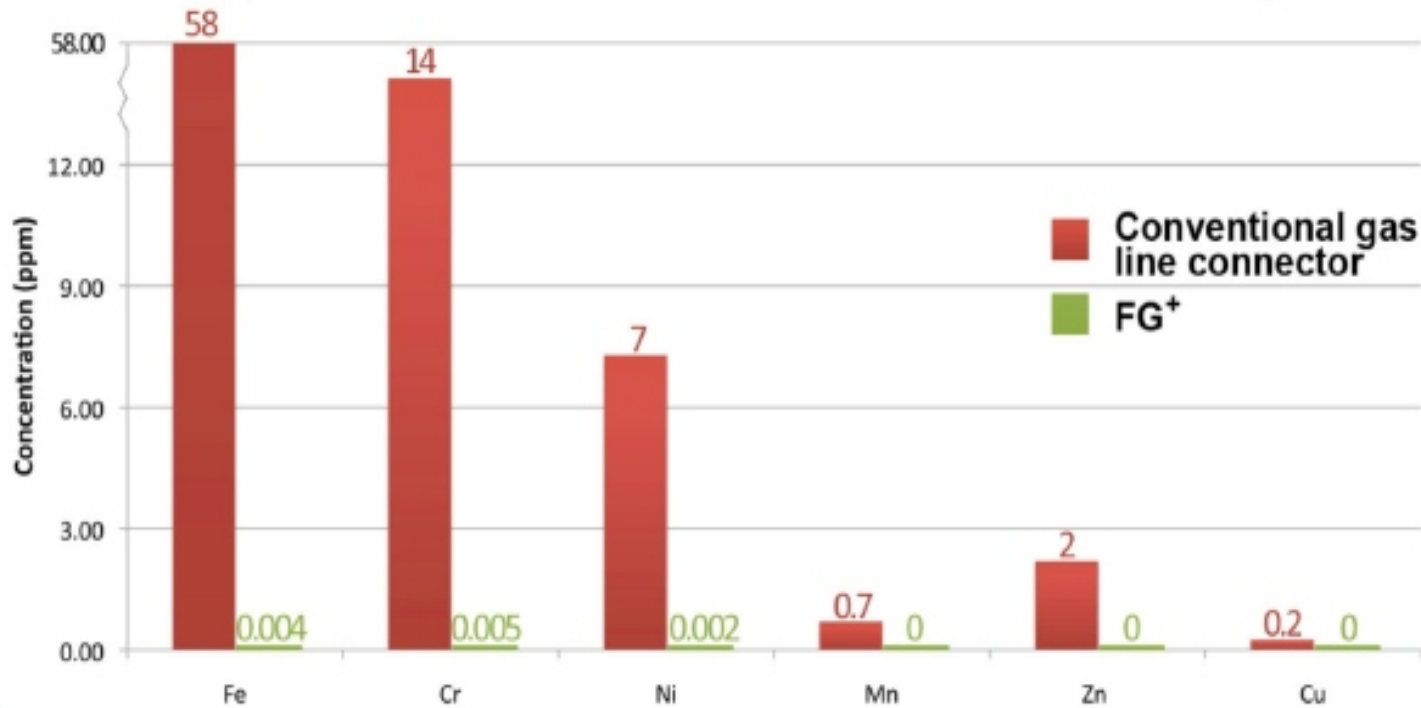

Conventional gas line connector



PFA FG<sup>+</sup> quick connect gas line

# 1990s Glass Expansion

Sample line was held with Teflon fitting.



Gas lines were Tygon tubing pushed over the barb.  
they regularly popped off if the pressure was 40+ psi



# 2012 Glass Expansion

**Machined inner capillary “Vitricone design”  
Constant ID for whole length:  
plugging mainly occurs at connection.**



**Gas lines are connected  
with secure fittings with O ring seals.  
Tight fit - no lines popping off.**

John A. Burgener

 Burgener Research Inc.

# 2012 Glass Expansion

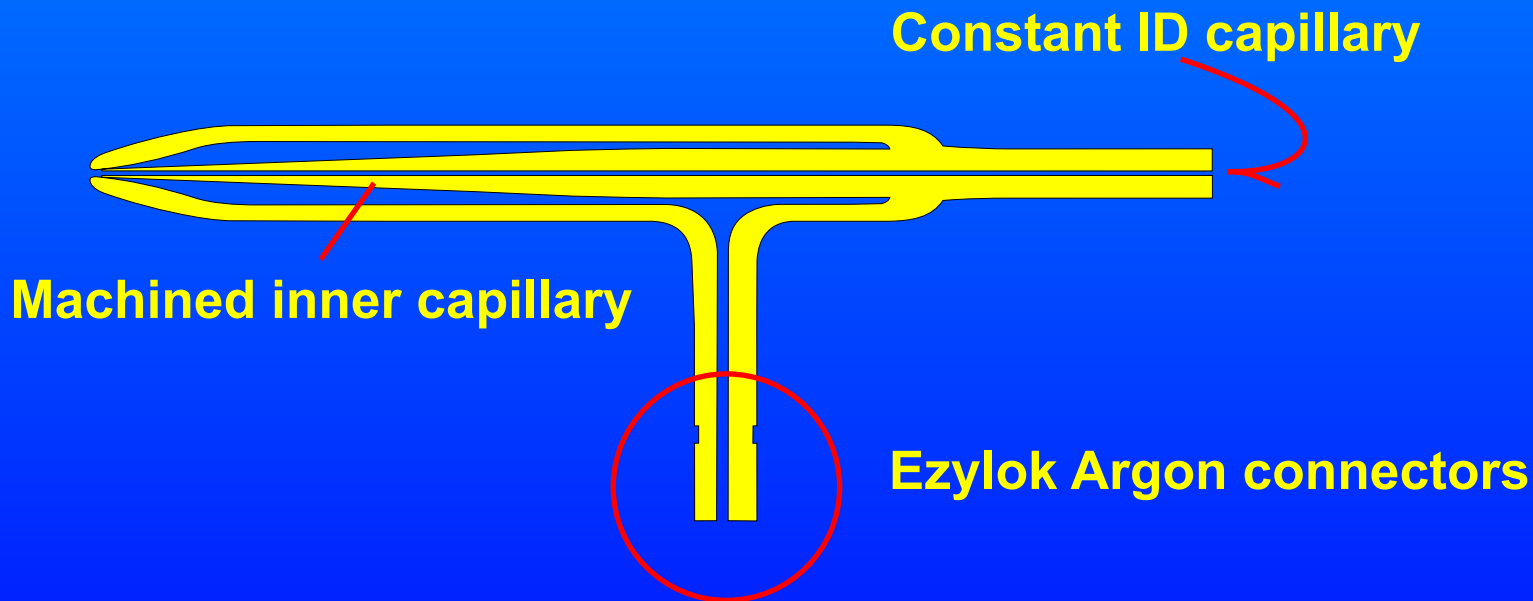

**Machined inner capillary "Vitricone design"**

**Constant ID for whole length:**

**plugging mainly occurs at back of nebulizers**

**First Glass Concentric design that matches**

**Burgener or ESI's PFA constant ID**

**More secure gas line attachments.**

# 2012 Precision Glassblowing

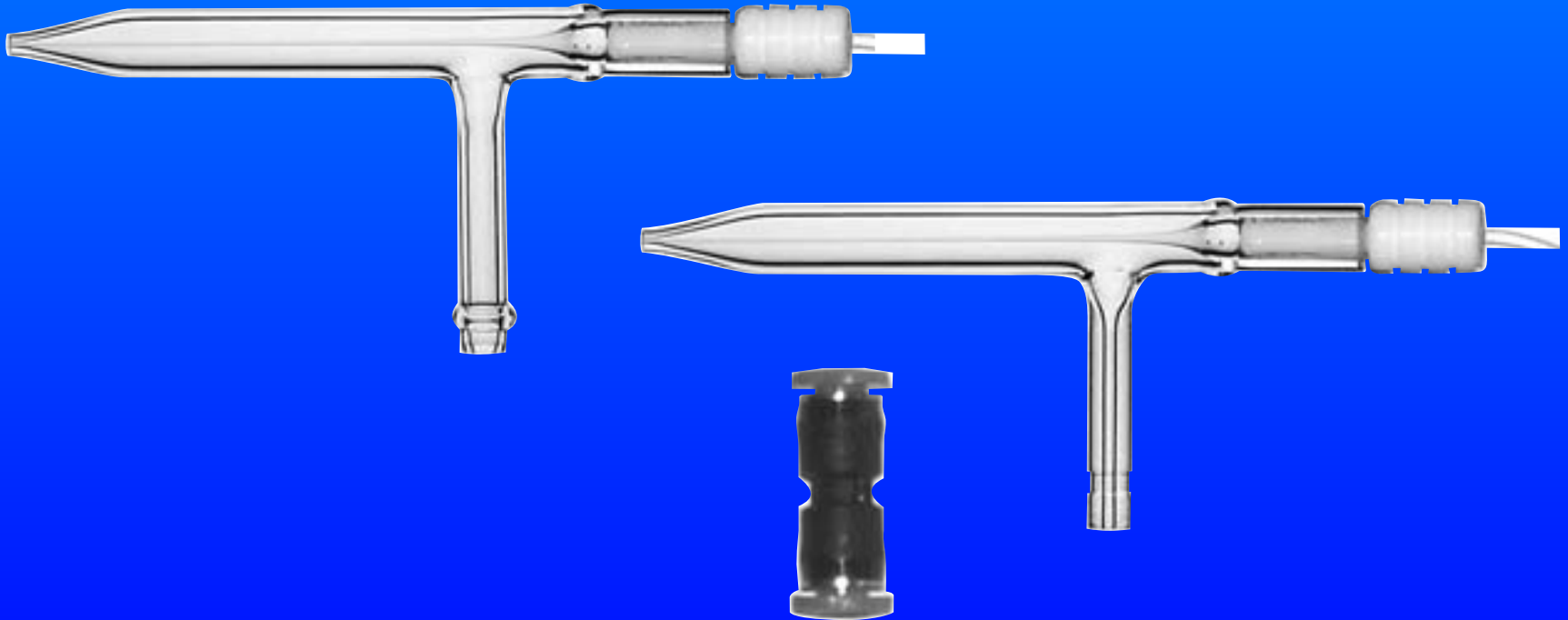

**Optional Tygon tubing or Ezylok gas line fitting.  
Wide range of models  
Design a mix of Meinhard and GE features**

John A. Burgener

 *Burgener Research Inc.*

# 2004 Epond's Tyfoon Concentrics



## *the EPOND 'Tyfoon'*

- *higher efficiency*
- *higher sensitivity*
- *higher salt tolerance*

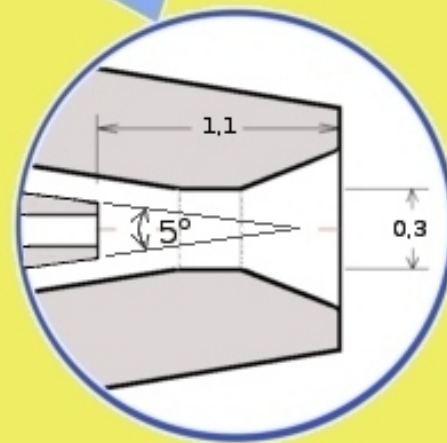

**They have a Laval-type nozzle at the tip of the nebulizer,  
Gives a more complete nebulization at higher sample flow rates.  
Available in glass, quartz and PTFE.**

# Epond's Lucida: 1 $\mu\text{l}/\text{min}$ Microconcentric

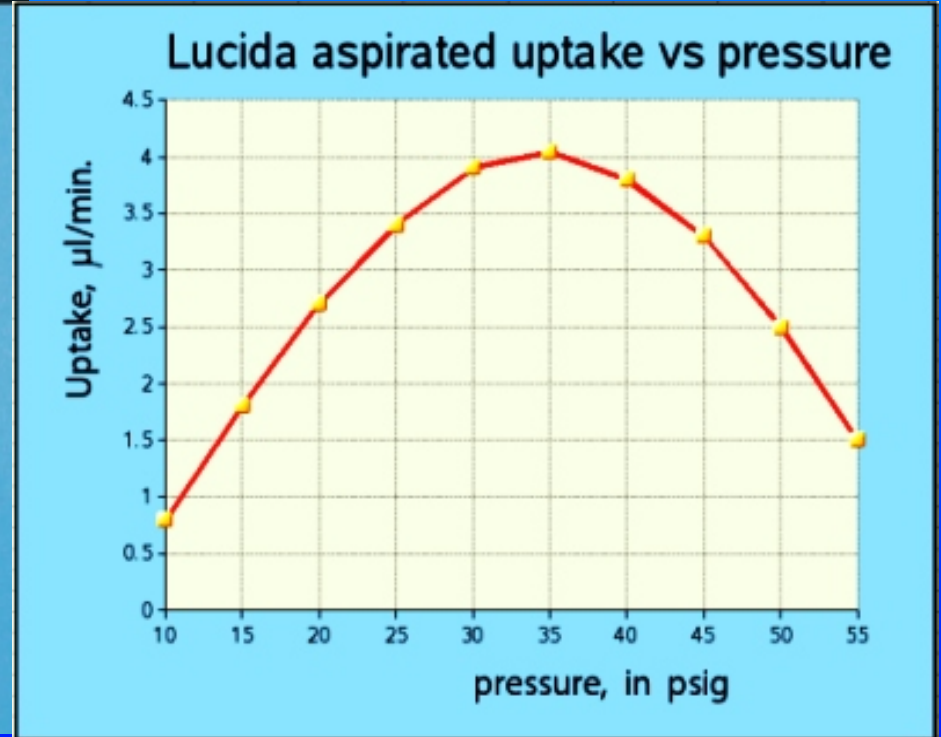
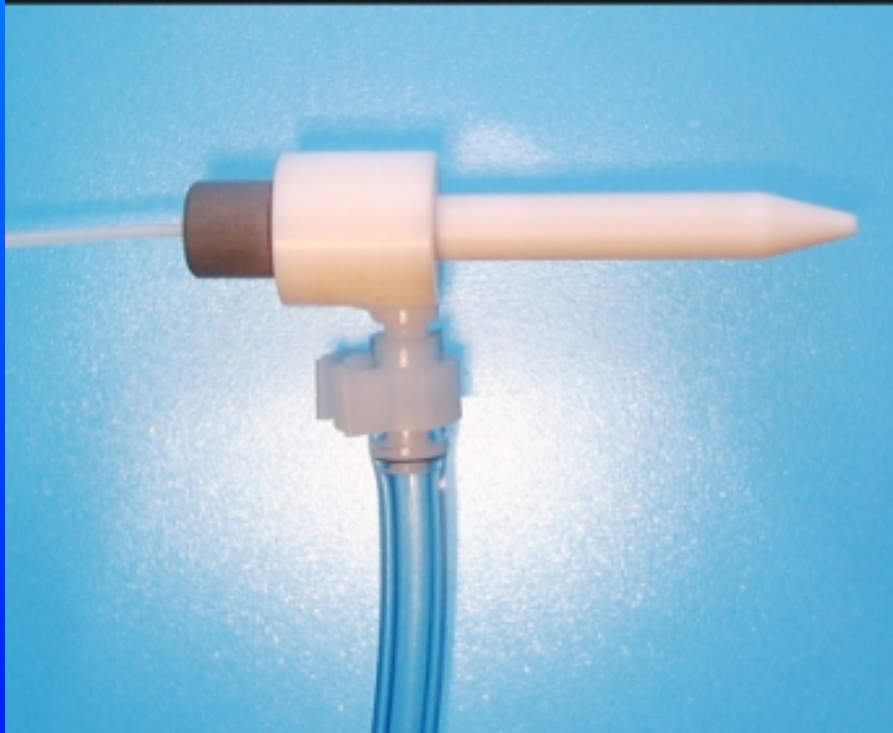

**The Lucida is unique  
in that its natural aspirated uptake is below 10  $\mu\text{l}/\text{min}$ .  
It can run from 1 to 50  $\mu\text{l}/\text{min}$ .**

John A. Burgener

 Burgener Research Inc.

# Until 2001, all pneumatic nebulizers used induction.

Gas moving out of an orifice moves in a reasonably straight line. There is little sideways motion.

Molecules beside the gas stream are not pushed away, so they move towards the gas stream as though there was a vacuum.

As molecules move into the gas stream, they are impacted by the gas stream and move away with the gas stream.

Induction pulls liquid into gas stream.

Concentric  
Cross flow  
Babington V Groove  
Original Parallel Path  
All use induction

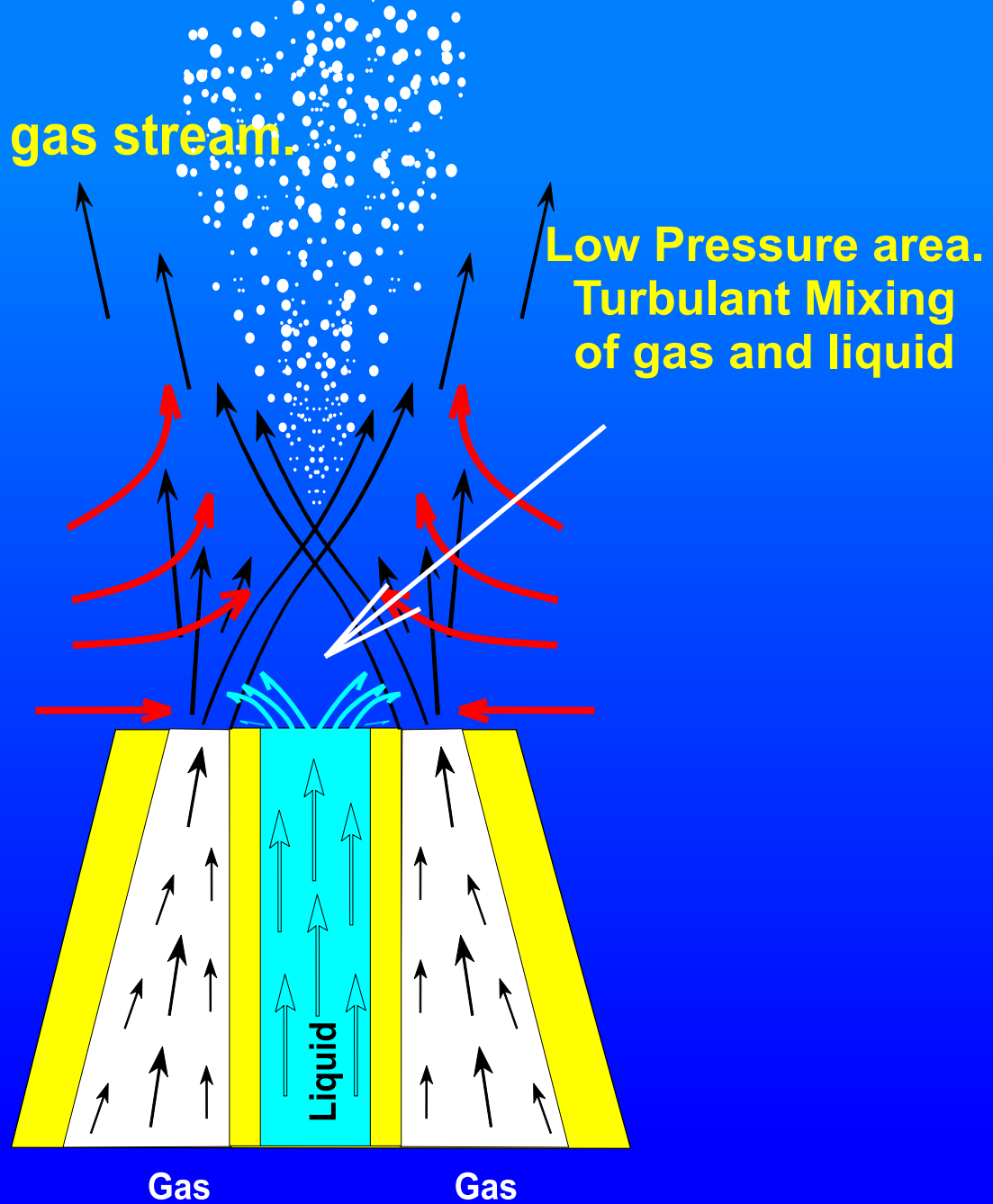

John A. Burgener

 Burgener Research Inc.

# New concepts in nebulizers since 2000:

## Burgener Enhanced Parallel Path Method

Evolved from Parallel Path

## OneNeb Flow Blurring

Evolved from Concentric

## Pizeoelectric Vibrating Mesh

Evolved from Ultra sonic

John A. Burgener

 Burgener Research Inc.



# New concepts in nebulizers since 2000:

## Burgener Enhanced Parallel Path Method

Evolved from Parallel Path

## OneNeb Flow Blurring

Evolved from Concentric

## Pizeoelectric Vibrating Mesh

Evolved from Ultra sonic

**ALL OF THESE ARE NEW CONCEPTS IN NEBULIZATION  
NOT JUST ENHANCEMENTS OF PREVIOUS DESIGNS  
AND NONE OF THESE USE INDUCTION**

John A. Burgener

 Burgener Research Inc.

# Pizeoelectric Vibrating Mesh

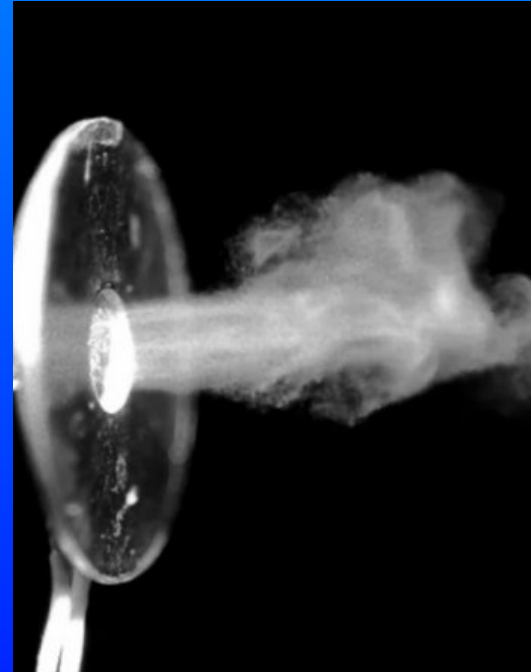

**A variation on Ultrasonics**

**The vibrating membrane has micro holes in it**

**The sample enters from the back and is pushed out the holes as the membrane vibrates.**

**Makes a fine mist with droplet size set by hole size.**

**Requires NO GAS FLOW**

John A. Burgener

 Burgener Research Inc.

# Pizeoelectric Vibrating Mesh

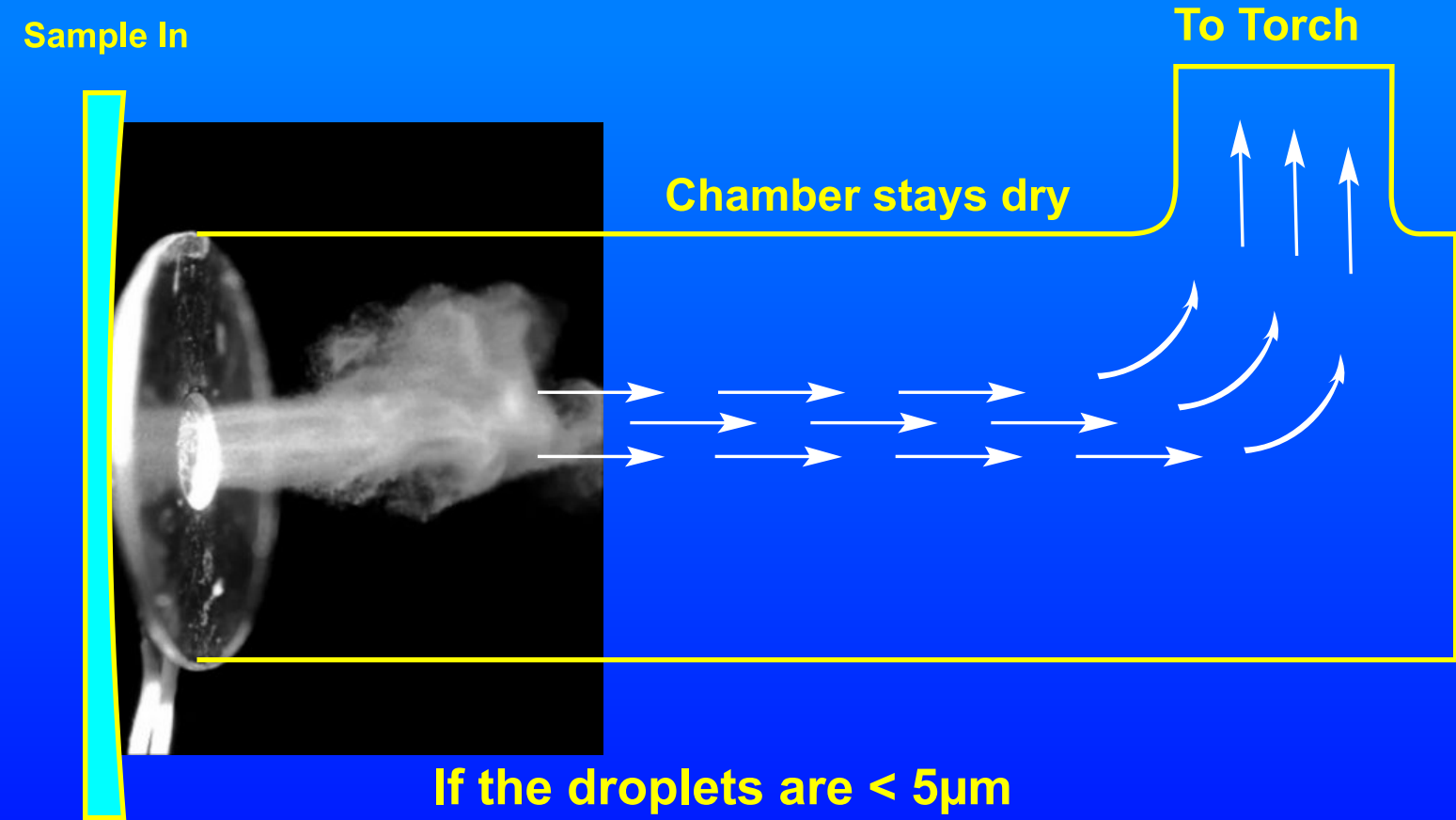

If the droplets are  $< 5\mu\text{m}$  then they are too small to stick to the walls of the chamber. the chamber remains dry, and 90-100% of the sample goes to the torch. With no gas flow required, very low Argon flows are possible.

# Pizeoelectric Vibrating Mesh

Sample In

To Torch

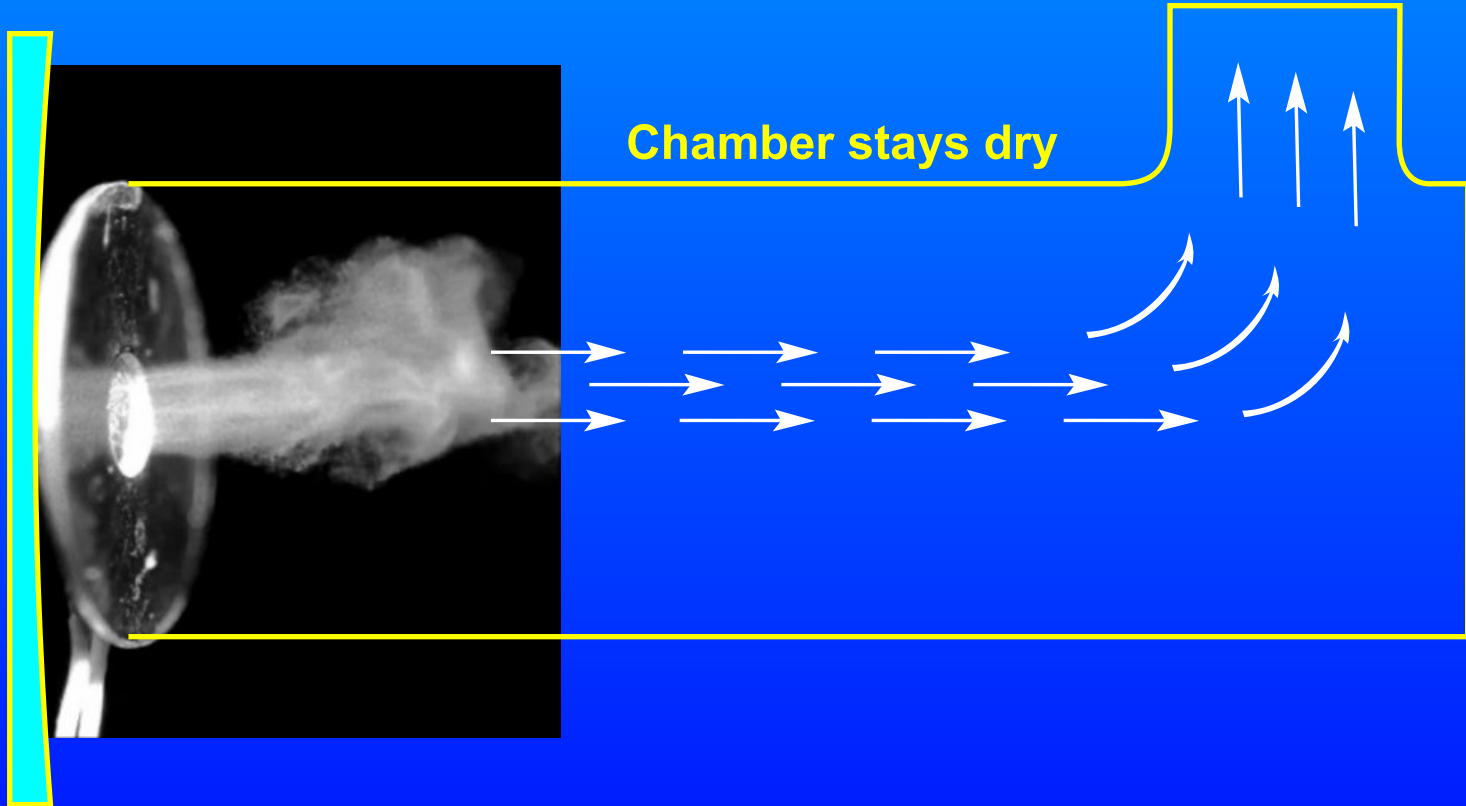

Sample Out

## Advantages:

**Droplet size set by hole size. All droplets same size.**

**If running < 15  $\mu$ l/min then**

**100% vaporizes and goes to the torch.**

**Very low flow Argon - same as Laser ablation.**

John A. Burgener

 Burgener Research Inc.

# Pizeoelectric Vibrating Mesh

Sample In

To Torch

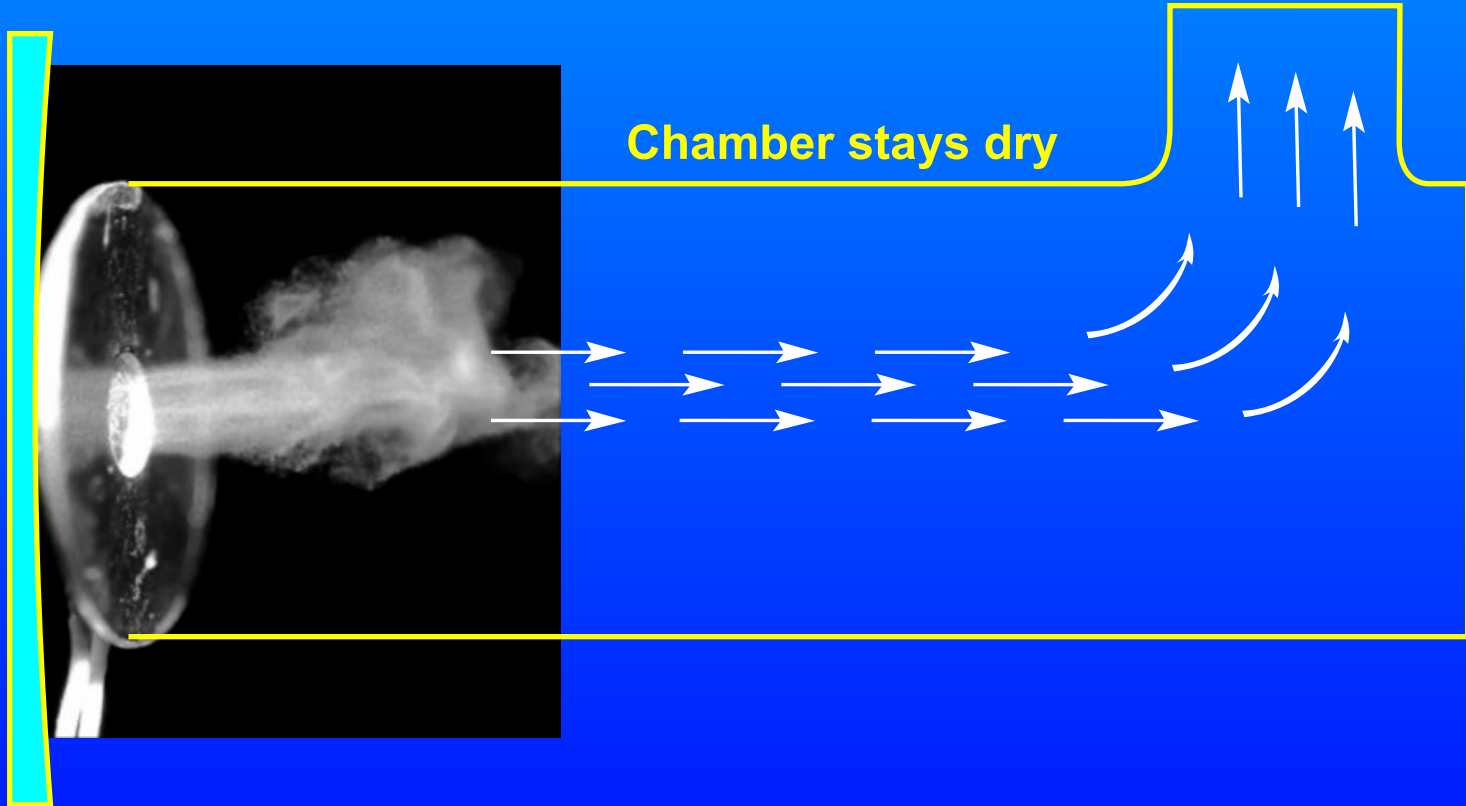

Sample Out

## Disadvantages:

If running  $> 40 \mu\text{l}/\text{min}$ , torch is overloaded, requiring use of desolvator.

Volume behind membrane  $>$  sample aspirated.

Holes  $< 5 \mu\text{m}$  are easy to plug.

Holes  $< 5 \mu\text{m}$  are easy to salt.

John A. Burgener

 Burgener Research Inc.

# Pizeoelectric Vibrating Mesh Summary

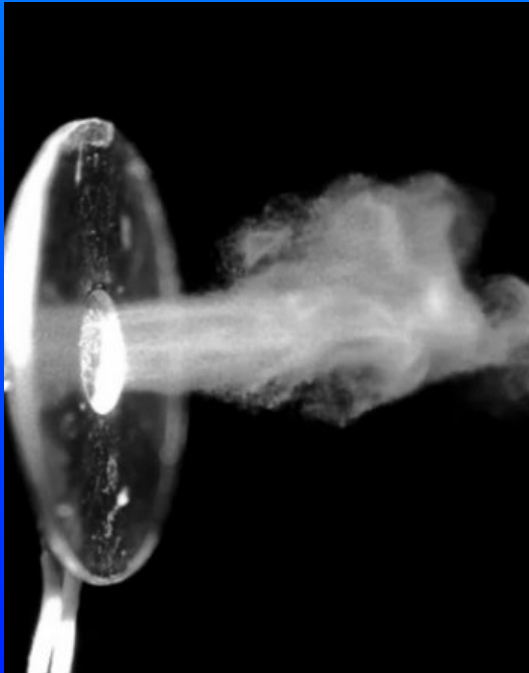

**Likely for ICP/MS applications only.**

**Will be a niche usage for applications:**

**needing minimal sample sent to torch.**

**having lots of sample to send to nebulizer.**

**clean solutions only.**

**low salts only.**

**Main New nebulizers since 2000:**

**Burgener Enhanced Parallel Path Method**

**OneNeb Flow Blurring**

**Pizeoelectric Vibrating Mesh**

**ALL OF THESE ARE NEW CONCEPTS IN NEBULIZATION  
NOT JUST VARIATIONS ON PREVIOUS DESIGNS**

John A. Burgener

 *Burgener Research Inc.*

# 2001 Burgener Mira Mist



**Looks like a Micro 3 but very different.**

John A. Burgener

 Burgener Research Inc.



# 2001 Burgener Mira Mist

**Micro 3  
Parallel Path Design**



**Mira Mist  
Enhanced  
Parallel Path Design**

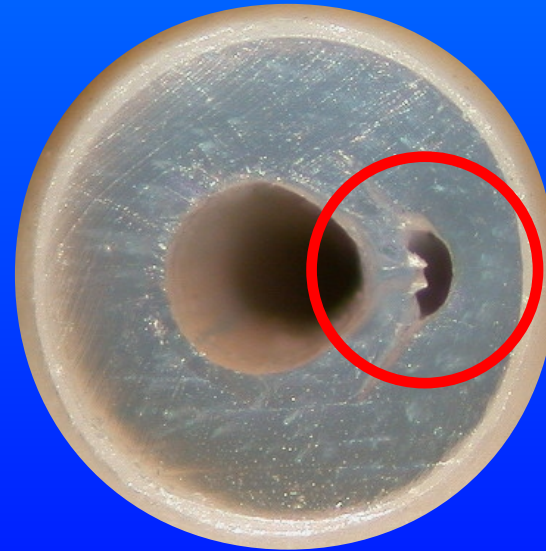

**Dramatically different gas orifice  
Dramatically different interaction  
between gas and liquid**



**Close-up of the Tip of a Burgener Nebulizer.**

# The Parallel Path Method

Induction pulls liquid into gas stream.

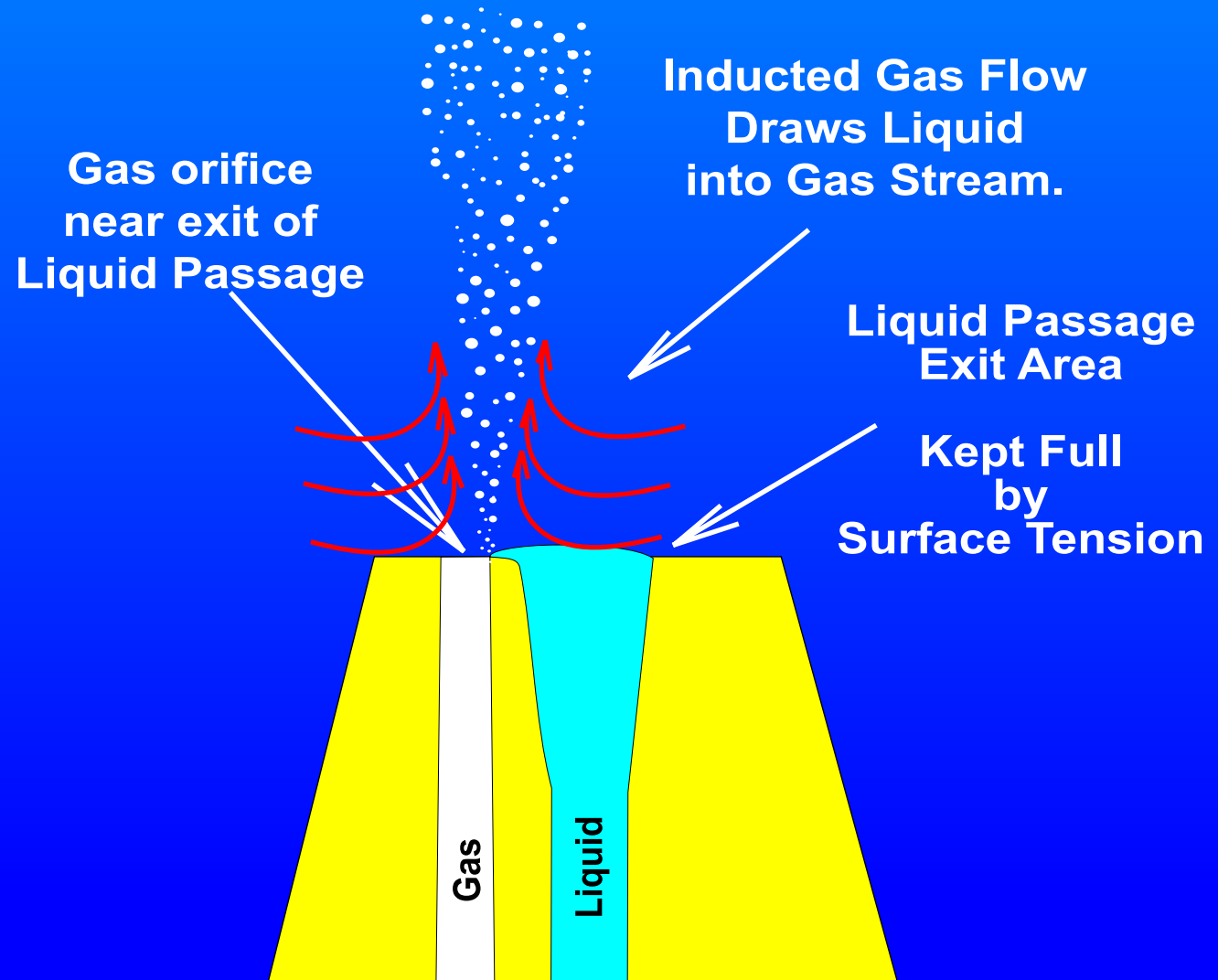

John A. Burgener

 Burgener Research Inc.

# Enhanced Parallel Path Method

Surface tension  
pulls liquid into spout.  
Gas molecules impact liquid  
breaking it into small droplets.

Interaction is at  
center of gas stream,  
Energy transfer is  
10X greater  
than from edge.

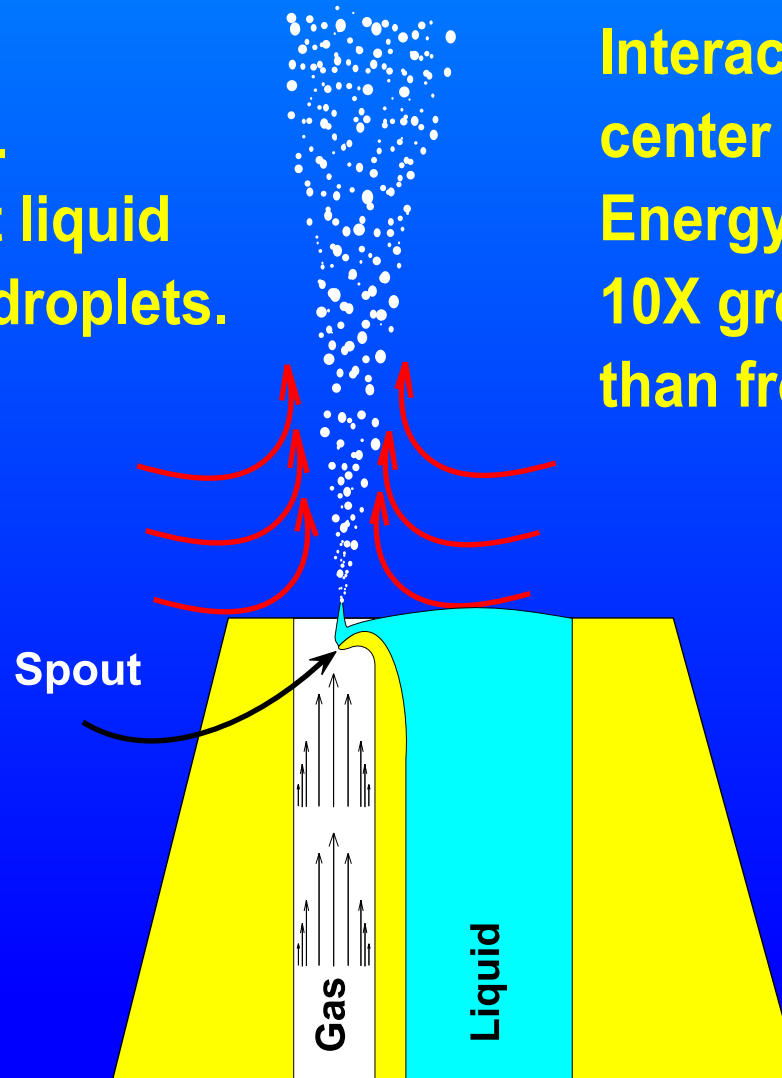

John A. Burgener

 Burgener Research Inc.



# Enhanced Parallel Path Method

The Enhanced Method does not use gravity or induction. As such, it has zero back pressure and zero suction, and operates equally well in any orientation.

The liquid interacts with the gas stream in the central portion of the gas stream. Gas streams in capillaries have velocity gradients across the diameter of the capillary, with the slowest gas moving at the edges of the capillary and the fastest at the center. The central gas flow is 3 to 10 times as fast as the gas at the edge of the stream. If the central portion of the gas stream can impact the liquid, then the gas impacts the liquid with much more energy. Energy is related to the square of the velocity, so 3 to 10 times the speed is 9 to 100 times the energy. With such an increase in energy transfer from the gas to the liquid, the liquid is broken up into much smaller droplets. This produces a mist with average droplet sizes much smaller than any other method for the same gas flow and pressures.

# Mira Mist Nebulizer Characteristics:

**Normalized Size distribution for aerosol from Mira Mist on pure water, the most difficult liquid for a Mira Mist.**

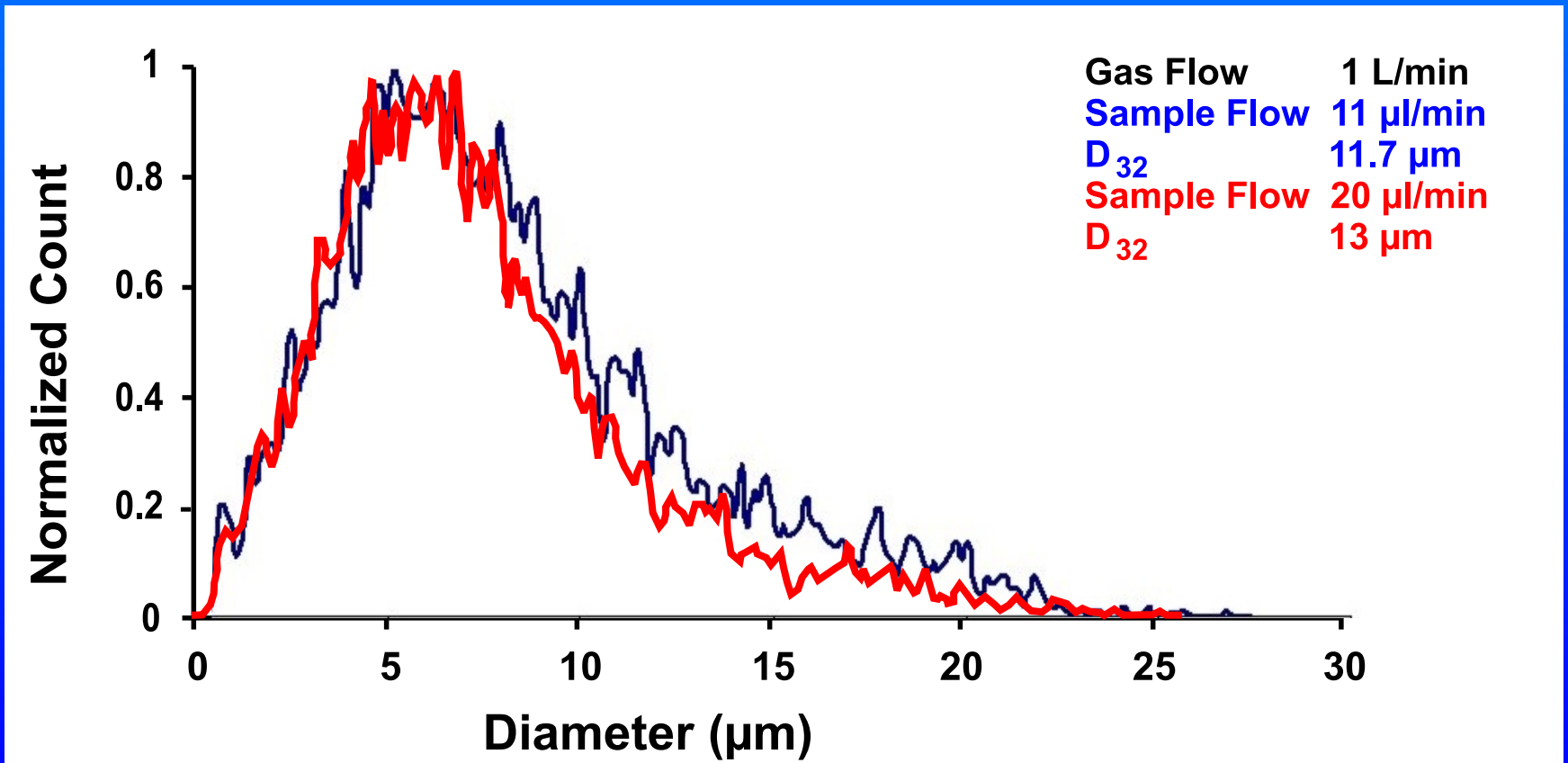

John A. Burgener

 Burgener Research Inc.

Data from Akbar Montaser,  
George Washington University

# Mira Mist Nebulizer Characteristics:

**Normalized Size distribution for aerosol from Mira Mist on pure water, the most difficult liquid for a Mira Mist.**

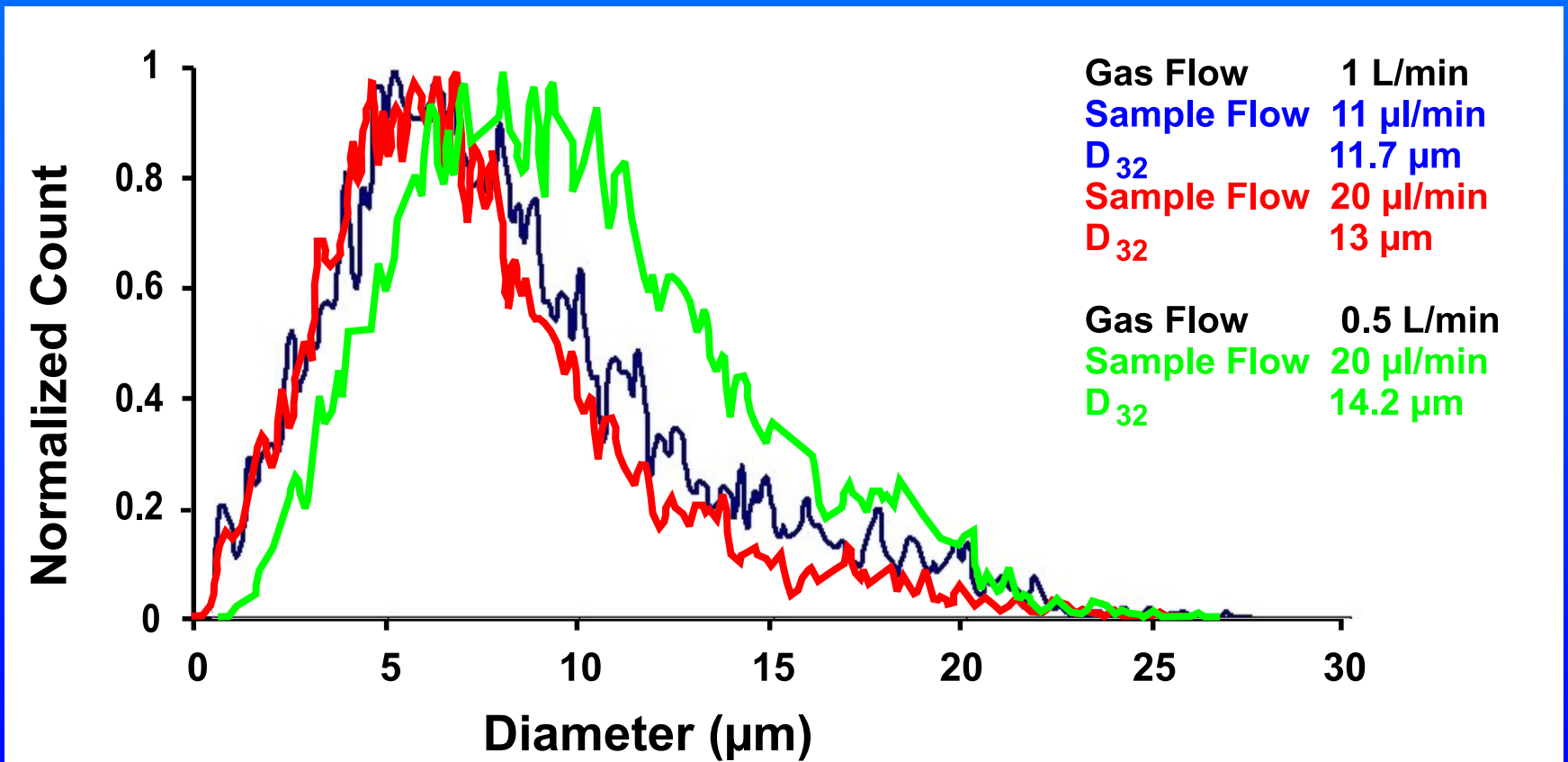

John A. Burgener

 Burgener Research Inc.

Data from Akbar Montaser,  
George Washington University

# High Stability

## Mira Mist Stability Plot

< 1% RSD for 3% NaCl over a 4 hour period

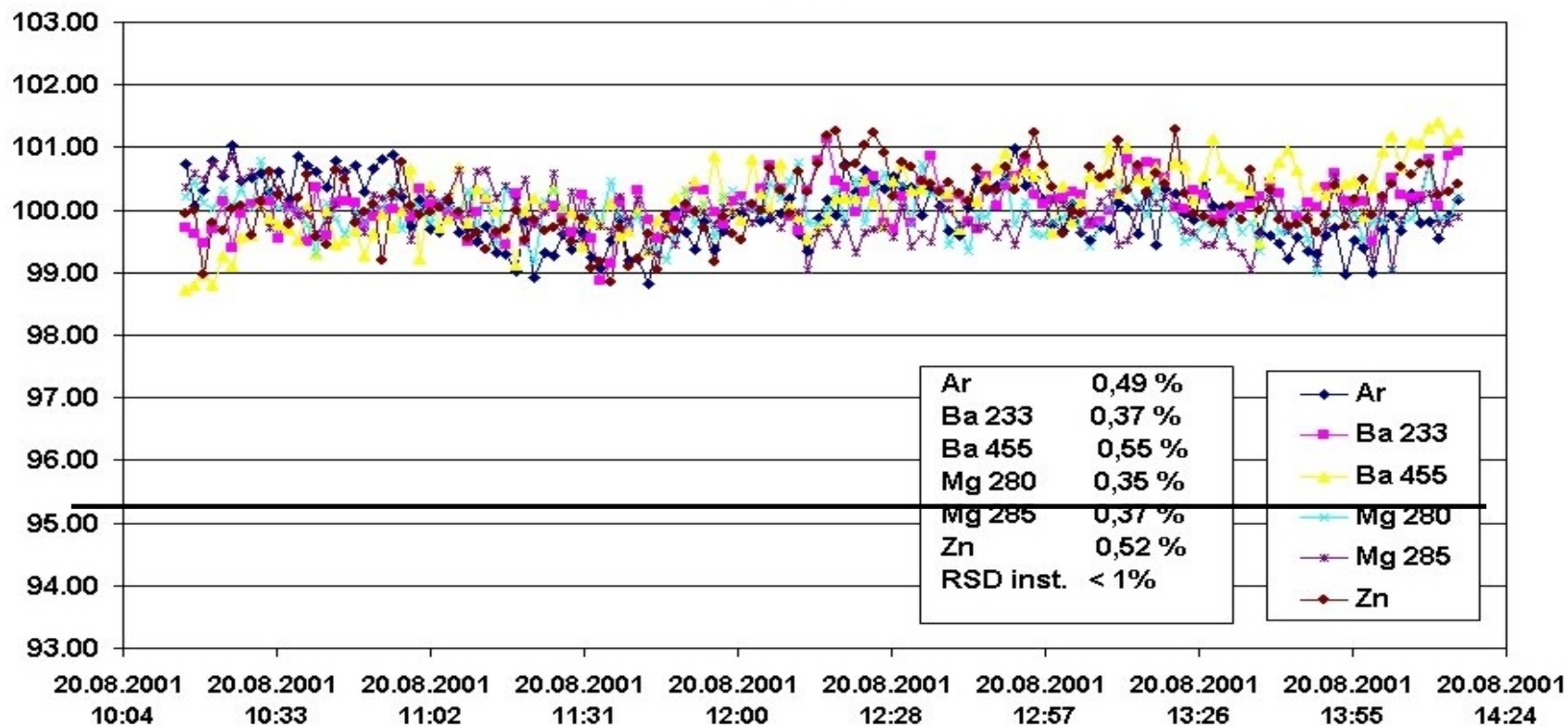

John A. Burgener

 Burgener Research Inc.

Data from Jobin Yvon, France



**ENHANCED PARALLEL PATH  
NEBULIZERS**  
for  
**ICP & ICP / MS**  
**2012 Product line**



**BETTER THAN THE BEST CONCENTRIC**

**Excellent Sensitivity and Precision  
with Little or No  
Drifting, Salting, Plugging,  
or Maintenance.**

**BR** *Burgener Research*

**3 MONTH SATISFACTION GUARANTEE**

# Comparisons of sample passages

**ARI MIST**  
225  $\mu\text{m}$

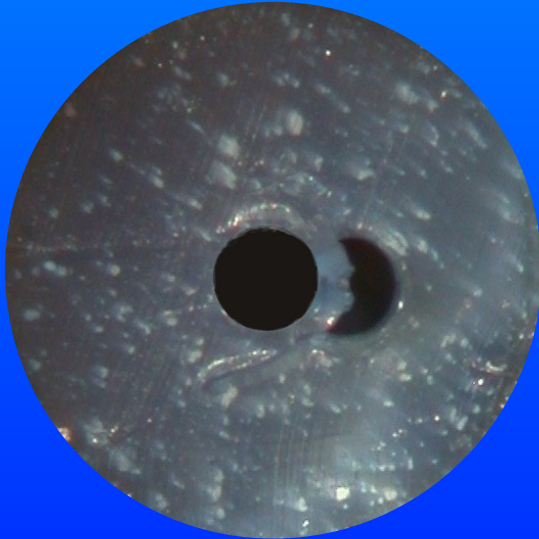

**MIRA MIST**  
500  $\mu\text{m}$



**T2100**  
760  $\mu\text{m}$

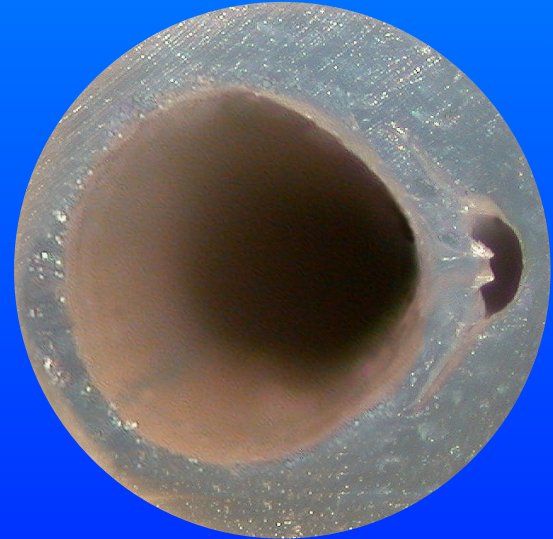

**Enya Mist**  
60  $\mu\text{m}$

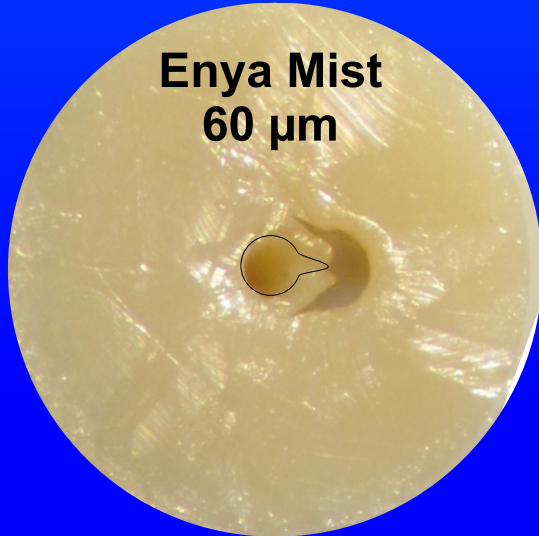

**Mira Mist CE**  
500  $\mu\text{m}$

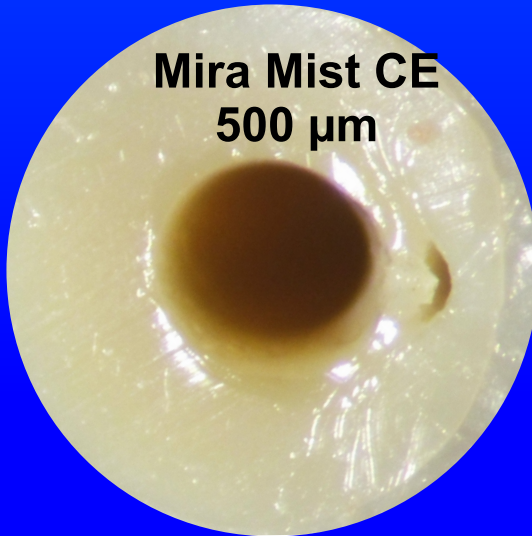

**Glass Concentric**  
200  $\mu\text{m}$

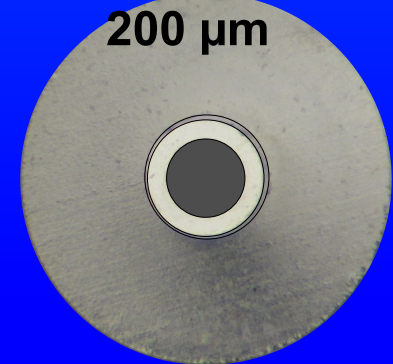

# Enhanced Parallel Path Summary



**Ideal nebulizers for almost all uses:**

**Excellent stability and sensitivity.**

**Handle high to saturated salts.**

**Handle large particles.**

**Micro flow and macro flow.**

**Non contaminating fittings and materials.**

**Rugged: provides exceptionally long life.**

John A. Burgener

 Burgener Research Inc.

**Main New nebulizers since 2000:**

**Burgener Enhanced Parallel Path Method**

**OneNeb Flow Blurring**

**Pizeoelectric Vibrating Mesh**

**ALL OF THESE ARE NEW CONCEPTS IN NEBULIZATION  
NOT JUST VARIATIONS ON PREVIOUS DESIGNS**

John A. Burgener

 *Burgener Research Inc.*



## OneNeb, a novel nebulizer for modern times

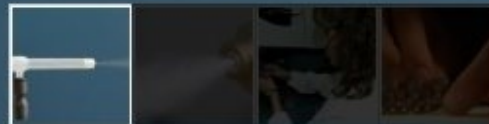

### The new line of nebulizers

OneNeb is a new line of nebulizers based on the Flow Blurring® nebulization technology and specifically designed for liquid sample uptake, utilizing inductively-coupled plasma-based analytical techniques (e.g., optical emission spectrometry ICP-OES and mass spectrometry ICP-MS) for elemental chemical analysis.

### Last News

Biomedal and Ingeniatics signs a distribution agreement for Cellena® bioencapsulator.

[Catálogo Interactivo de la OTRI](#)



# Presentation

## *Our product*

**OneNeb** is a new pneumatic nebulizer specially designed for use in liquid sample introduction systems for analytical atomic spectrometry techniques based on inductively coupled plasma (ICP-OES and ICP-MS).



The nebulization mechanism used is based on **Flow Blurring<sup>®</sup>** technology which is patented by the Spanish company Ingenialtrics.

# For Challenging Applications

## – OneNeb Nebulizer

- Robust PFA and PEEK construction
  - Inert - resistant to strong acids such as HF
  - Resistant to breakage
  - Molded plastic design provides improved nebulizer to nebulizer reproducibility
- Constant diameter narrow bore tubing through to nebulizer tip
  - Ideal for high solids/particulates
  - Improved tolerance to high TDS samples
- Narrow aerosol size distribution provides improved precision
- Handles a wide flow range from 0.1 to 2 mL/min.
  - No sensitivity loss at low flow rates



# Principle of Operation – Inert OneNeb Nebulizer

Tip geometry dimensioned to allow carrier gas to mix with the sample

Turbulent mixing of liquid and gas occurs

- Produces aerosol with a narrow size distribution range

Droplets mixed into gas flow

No area of low pressure

Unique Flow Blurring action increases nebulization efficiency

- Greater efficiency than conventional concentric nebulizer
- Improved sensitivity

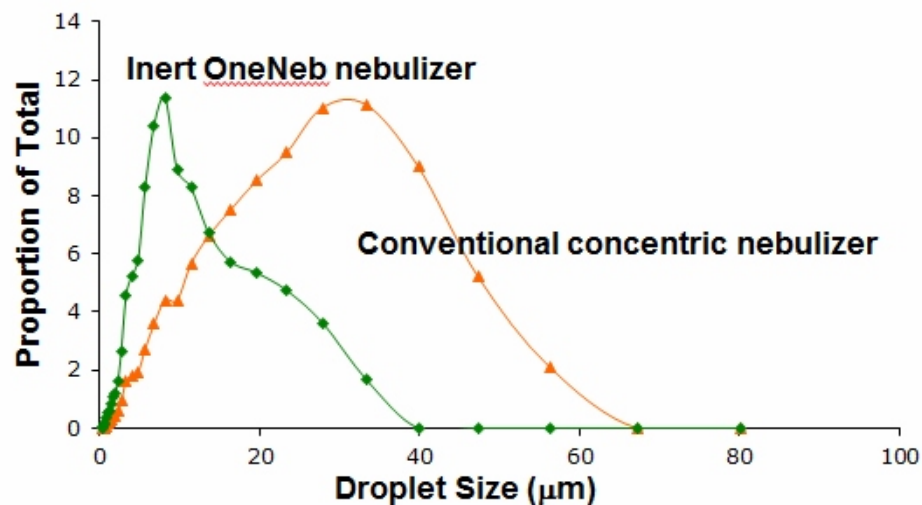
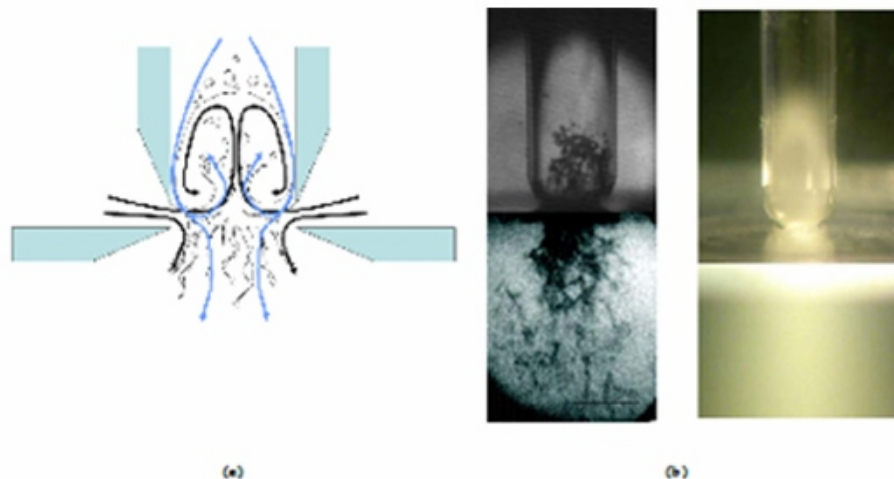



# Flow Blurring

This is NOT using induction !

# Concentric

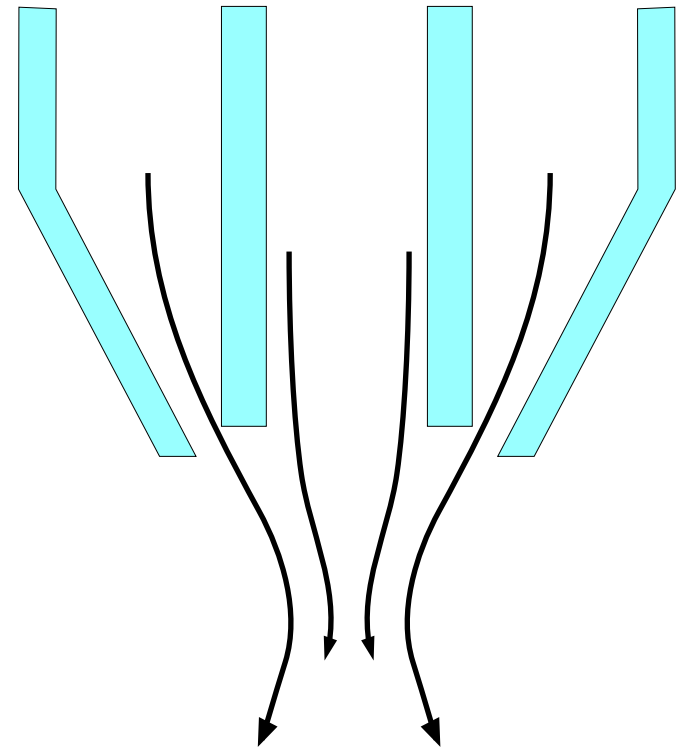
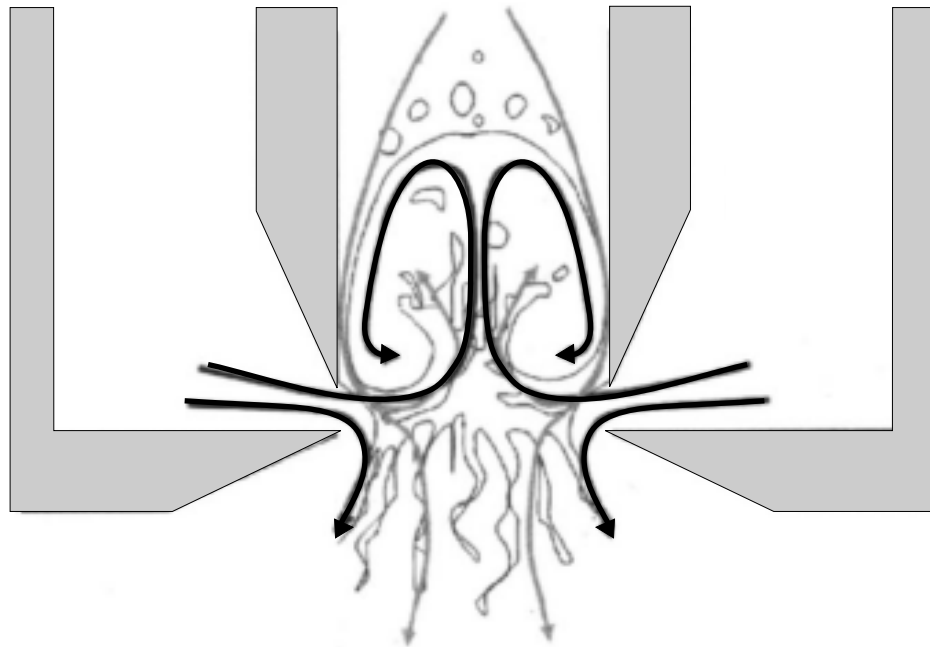

# Close Up Photos Flow Blurring

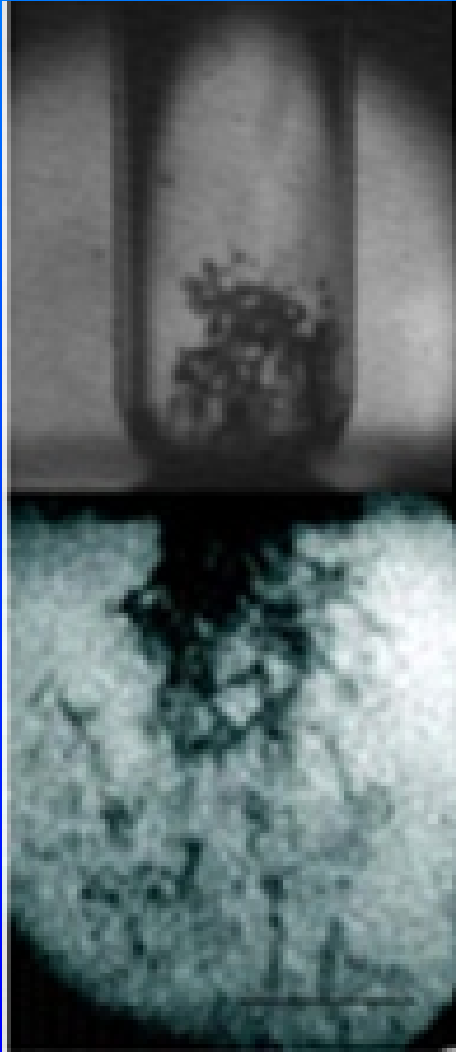

# Glass Concentric

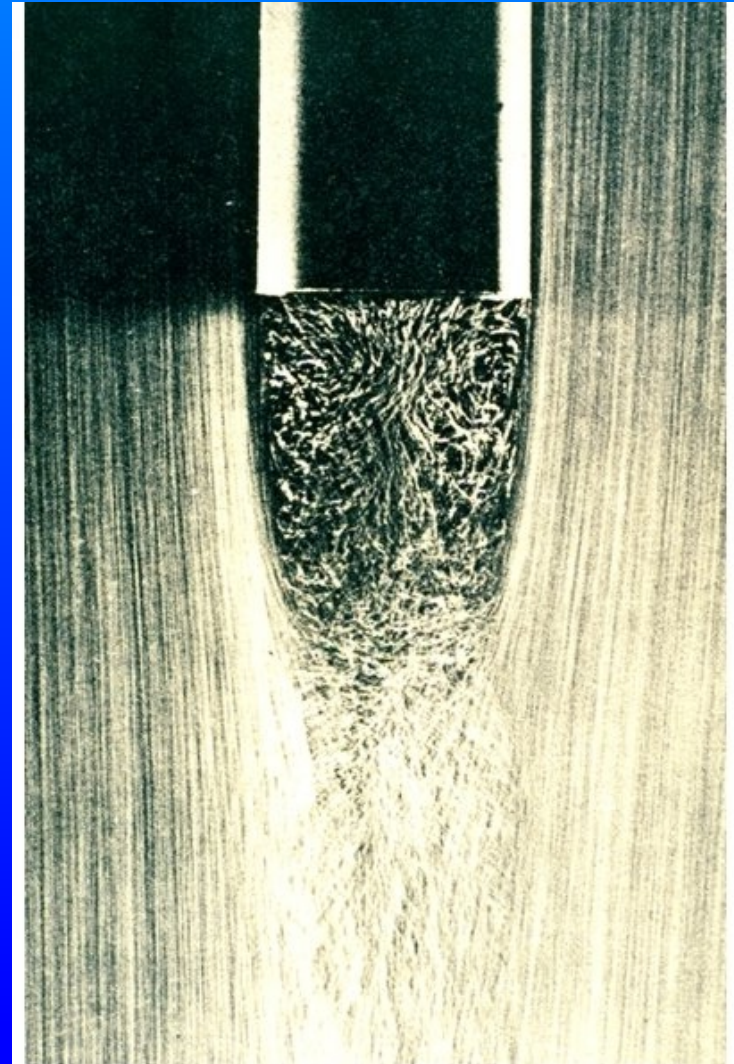

# OneNeb Normalized Stability Plot for 10 ppm S21+K solution over an 8 hour period

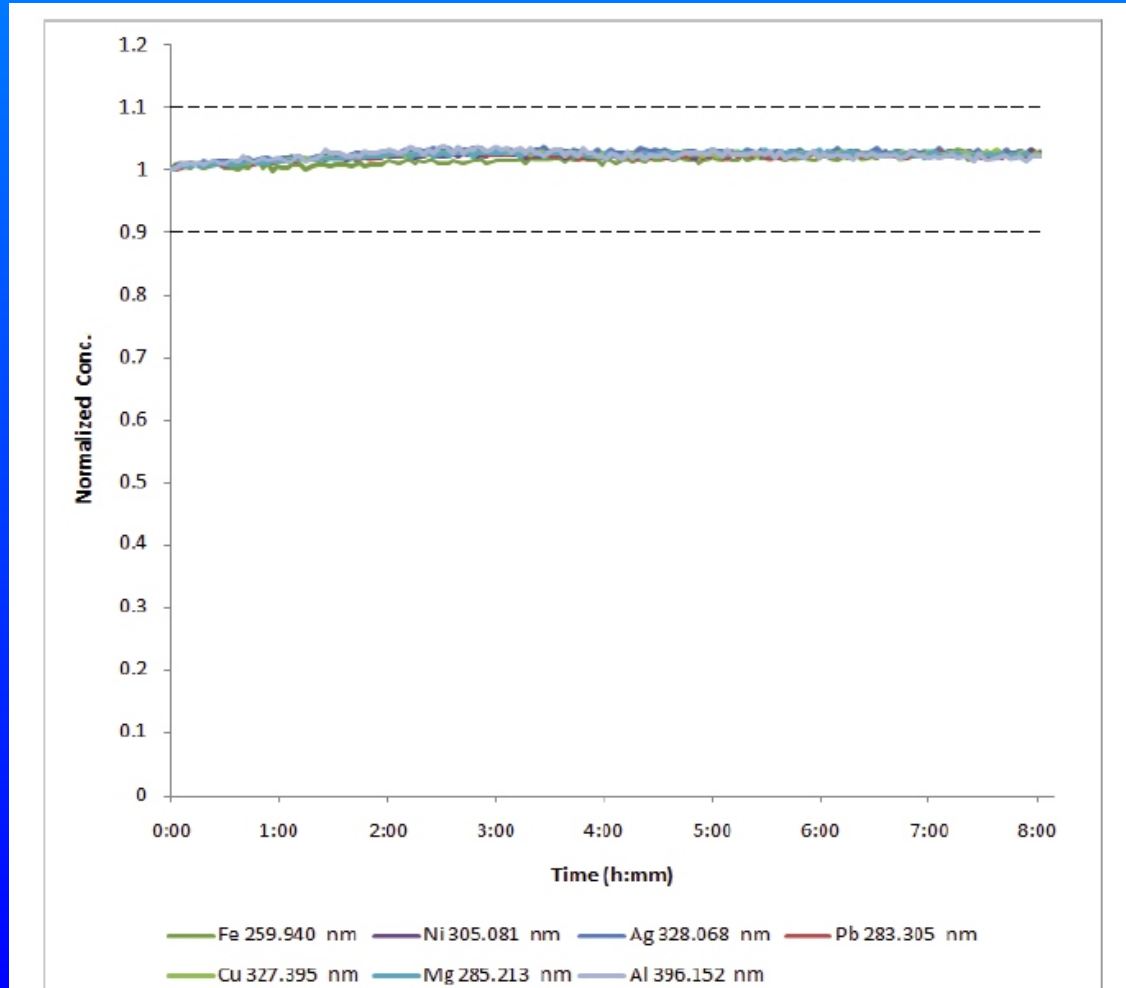

**Agilent Application note:**  
“Analysis of wear metals and contaminants  
in engine oils using the 4100 MP-AES”

**Authors:**  
Phil Lowenstern and Elizabeth Reisman  
Agilent Technologies, Melbourne, Australia

# OneNeb Normalized Stability Plot for 10 ppm S21+K solution over an 8 hour period

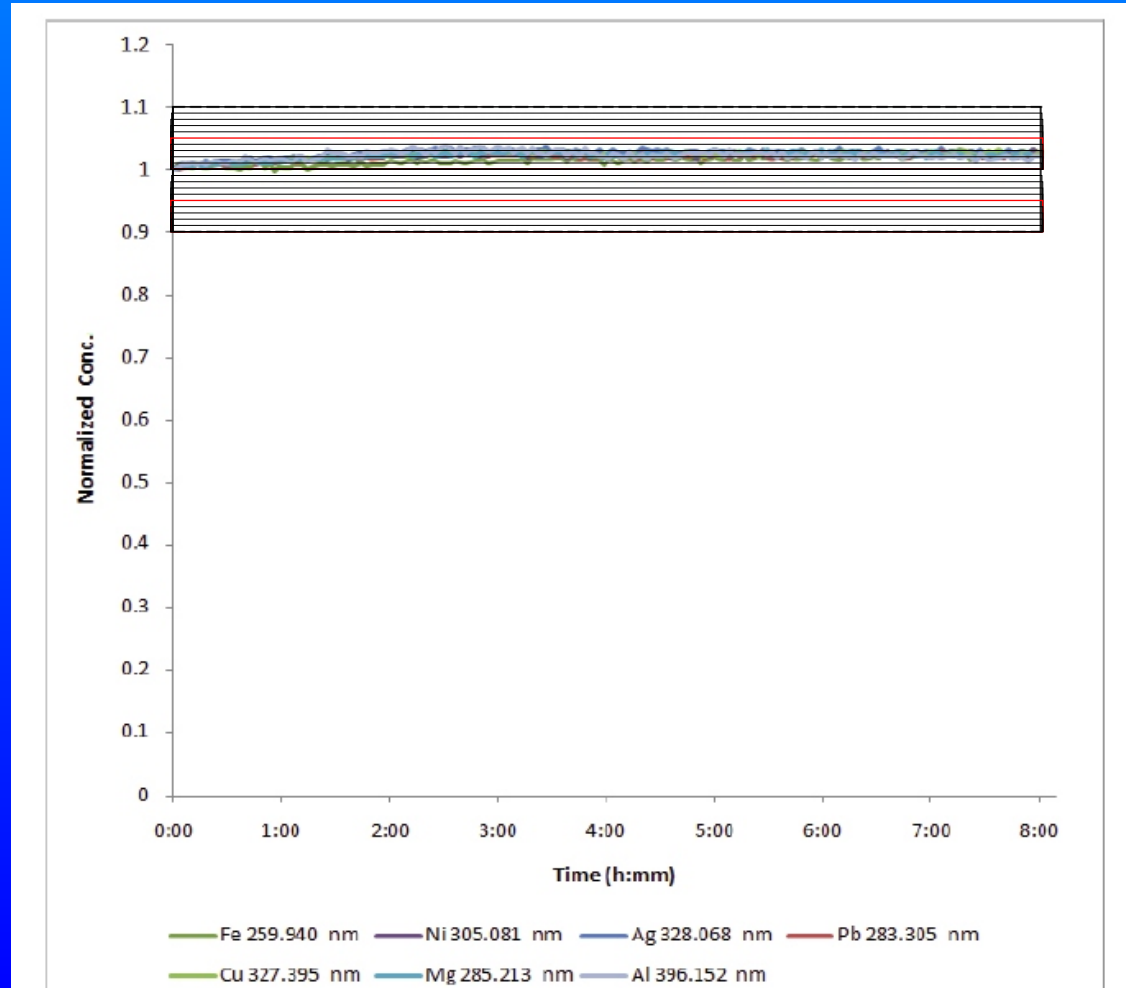

**Agilent Application note:**  
"Analysis of wear metals and contaminants  
in engine oils using the 4100 MP-AES"

**Authors:**  
Phil Lowenstern and Elizabeth Reisman  
Agilent Technologies, Melbourne, Australia

# OneNeb Normalized Stability Plot for 10 ppm S21+K solution over a 4 hour period

(This is half of the previous data, so 4 hours not 8.)

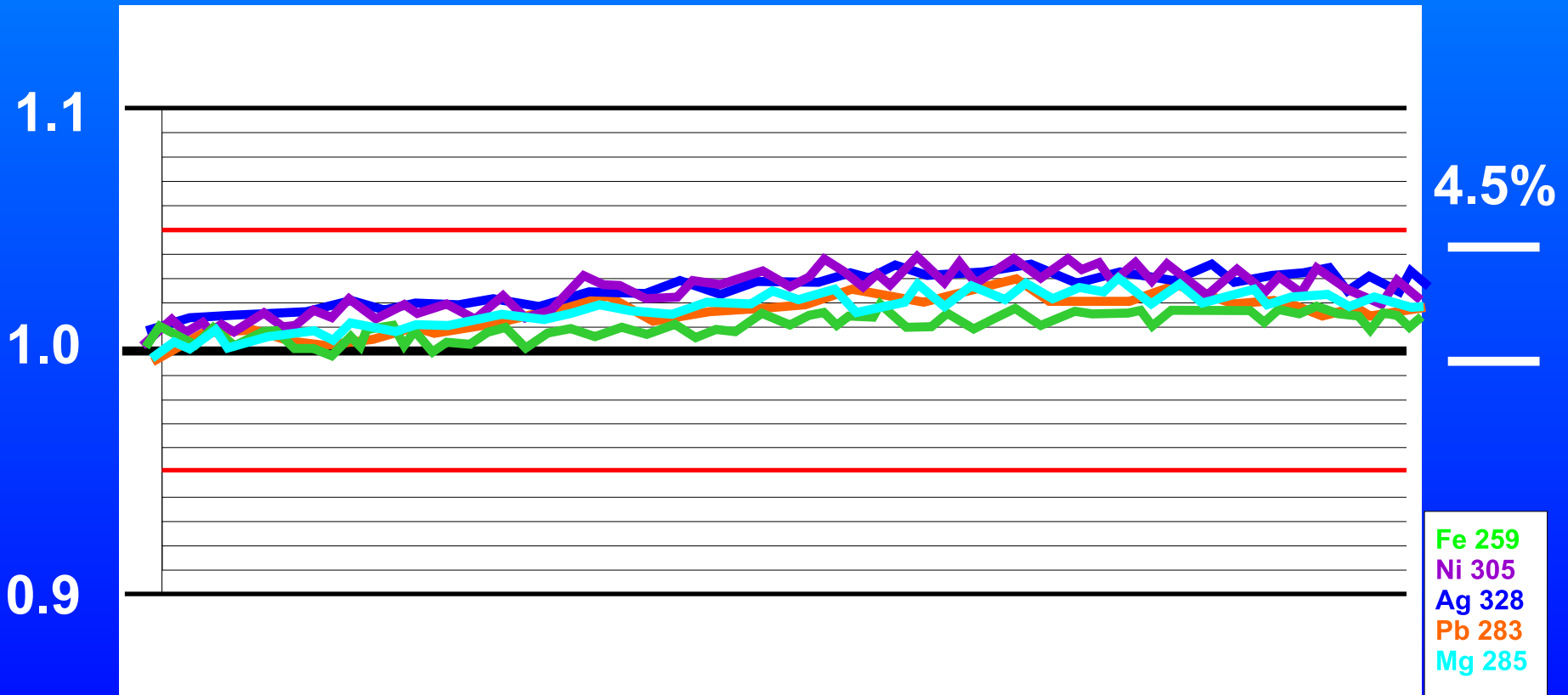

Agilent Application note:  
“Analysis of wear metals and contaminants  
in engine oils using the 4100 MP-AES”

Authors:  
Phil Lowenstern and Elizabeth Reisman  
Agilent Technologies, Melbourne, Australia

# Mira Mist Normalized Stability Plot for 3% NaCl over a 4 hour period

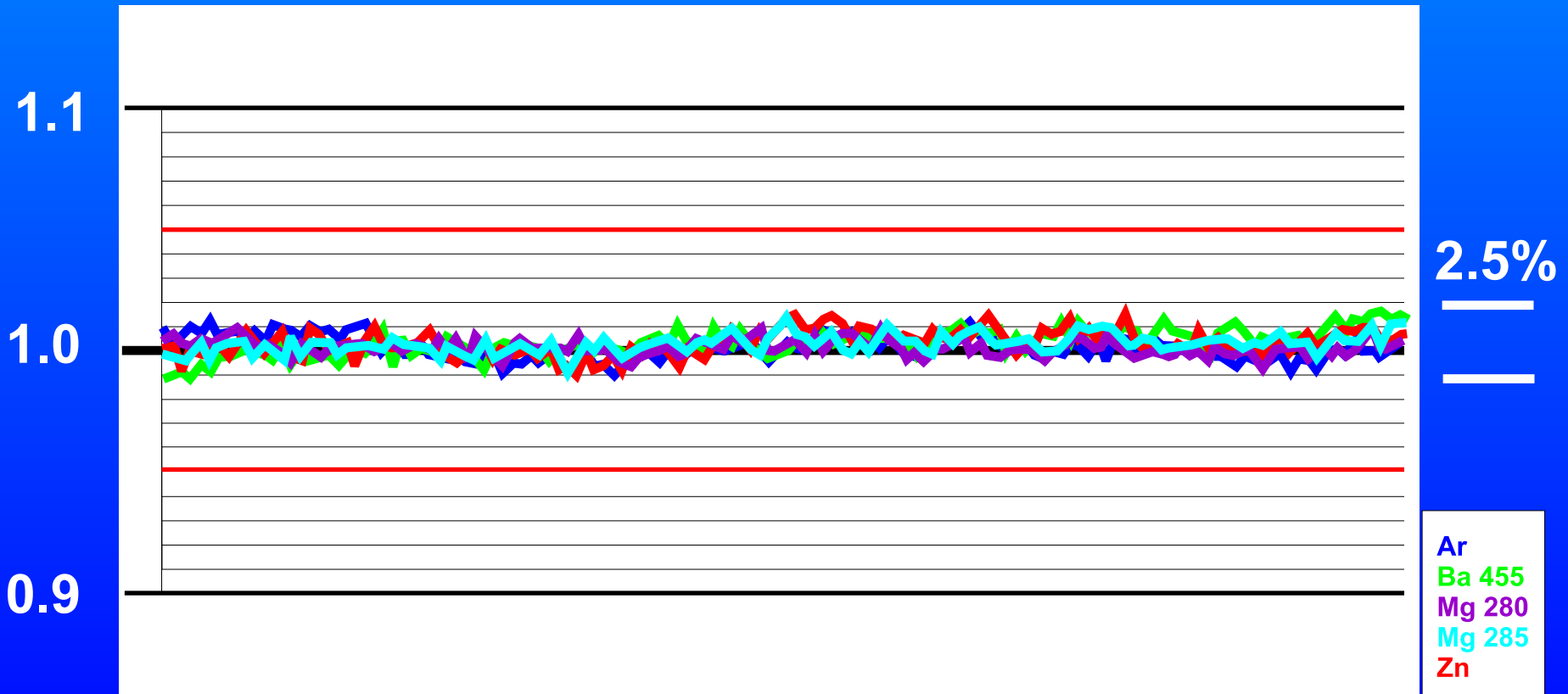

# DuraMist Long-term Stability

3.5%

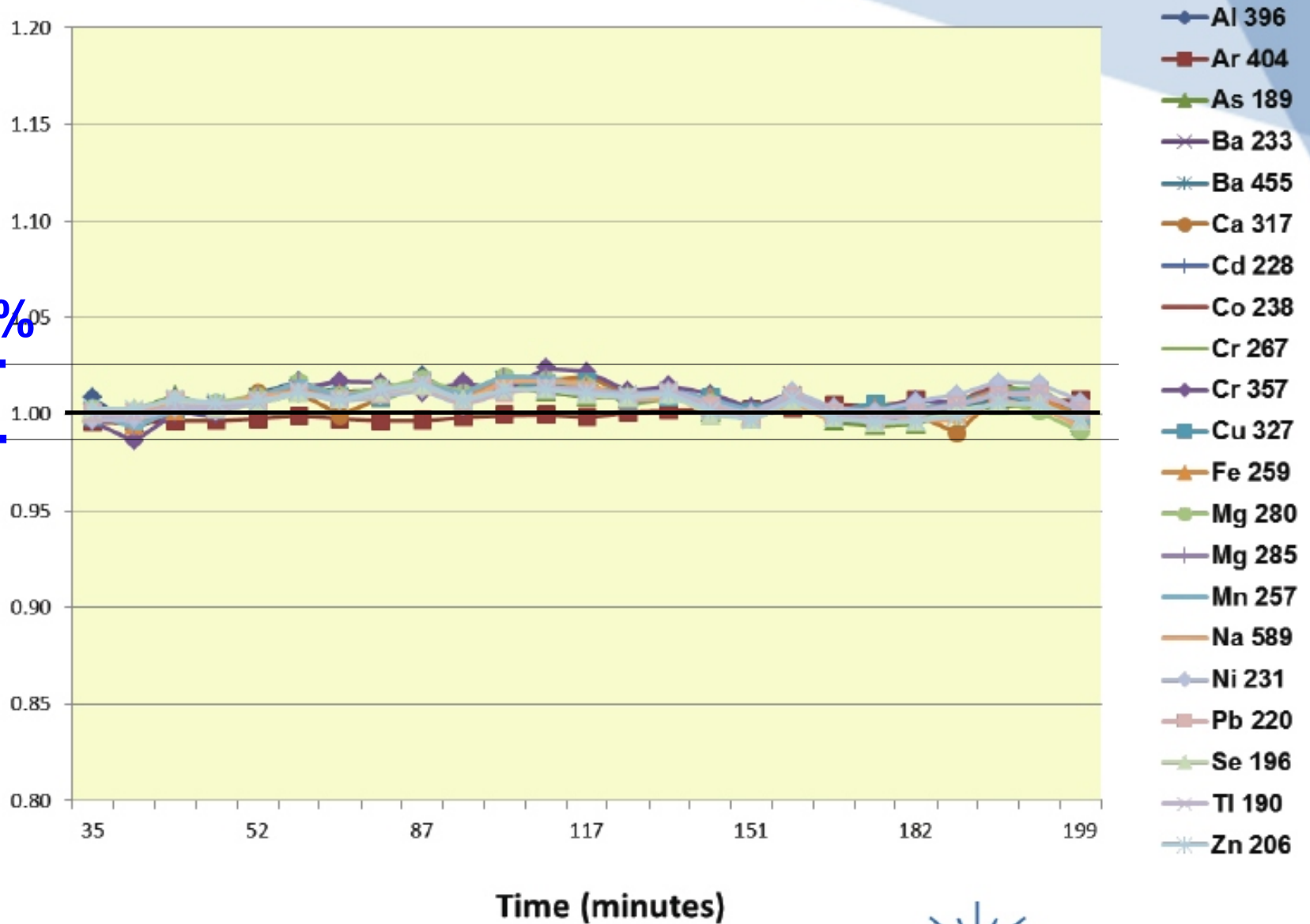

# OneNeb Review



*New Concept, claims to have smaller droplets.*

**Pro:**

**High Precision, Low Detection Limits,**

**Because it has no low pressure zone, it should not salt.**

**Handles High Salts, Wide range of flow rates.**

**As with any micro nebulizer,**

**for < 50 ul/min can deliver nearly 100% to torch.**

**Con:**

**Small sample capillary - particles will plug**

**Rubber in Gas line fitting**

**- will cause some contaminations**

**Back Pressure can blow off sample lines**

**Smaller droplets will drown torches**

**unless running low flow or using a desolvator.**

**Claims of perfection seem to be based on**

**comparisons with non-optimized other nebulizers.**





# What's New in Nebulizers

## PART 3: Some comments on Micro Nebulizers

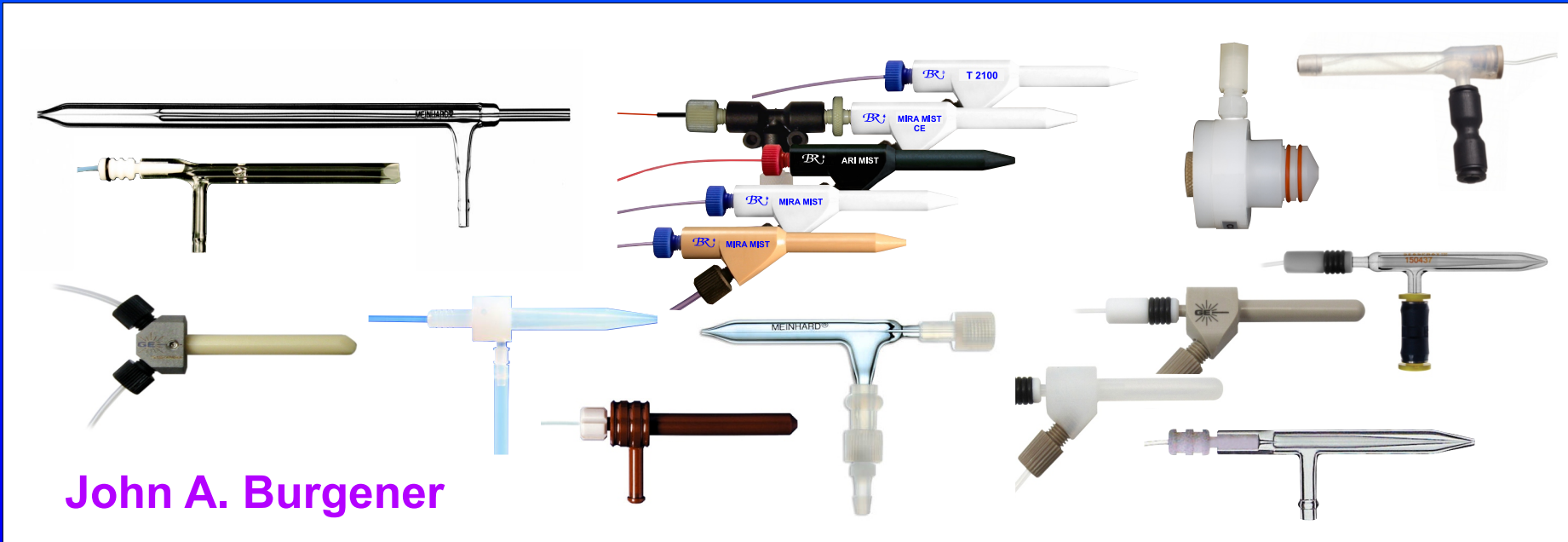

# The main Micro Nebulizers available today

## Microconcentric Nebulizers:

- Aspire** – CETAC (TFE, PFA)
- CEI-100** – CETAC
- MicroMist** – Glass Expansion (glass)
- MicroFlow** – Elemental Scientific (PFA)
- HEN** – Meinhard (glass, quartz)
- Lucida, Zefyr, Boreal** – Epond (PTFE)

## Non-Concentric Nebulizers:

- Mira Mist CE, Ari Mist, Enya Mist, PFA 250** – Burgener
- OneNeb** – Ingeniatics

Enya Mist: 0.2 - 50  $\mu\text{l}/\text{min}$  @ 45 psi  
Ari Mist: 5 - 1500  $\mu\text{l}/\text{min}$  @ 45 psi  
PFA 250: 50 - 1500  $\mu\text{l}/\text{min}$  @ 45 psi  
Mira Mist CE: 1 - 2500  $\mu\text{l}/\text{min}$  @ 80 - 90 psi  
Lucida: 1 - 40  $\mu\text{l}/\text{min}$  @ 35 psi  
Zefyr: 5 - 100  $\mu\text{l}/\text{min}$  @ 35 psi

Boreal: 50 - 700  $\mu\text{l}/\text{min}$  @ 35 psi  
OneNeb: 10 - 2000  $\mu\text{l}/\text{min}$  @ 40 psi  
MicroMist: 100 - 500  $\mu\text{l}/\text{min}$  @ 30 - 60 psi  
MicroFlow: 20 - 700  $\mu\text{l}/\text{min}$  @ 60 - 70 psi  
High Efficiency Nebulizer: 30 - 300  $\mu\text{l}/\text{min}$  @ 90 - 170 psi  
Microconcentric Nebulizer: 100 - 500  $\mu\text{l}/\text{min}$  @ 60 - 90 psi

# Advantages of Micro and Nano flows

1 L of dry Argon can absorb 15  $\mu\text{l}$  of water.

**Running less than 15  $\mu\text{l}/\text{min}$  enables:**

(conditional on droplet sizes being  $< 10 \mu\text{m}$  and enough time allowed for vaporization or heating / desolvation being added)

**ALL of the sample vaporizes and goes to torch.**

**The chamber stays dry**

**Washout times drop from minutes to milliseconds.**

**Torch stability improves.**

**Speciation effects dramatically reduced.**

**ICP/MS interferences drop dramatically.**

**MS cones/skimmers last much longer.**

**HPLC,  $\mu\text{HPLC}$  and CE can have ALL sample to torch.**

**Micro samples can be run over a long period of time.**

**Organic solvents can be run without effecting the plasma.**

# Transport Efficiency vs. Uptake

Chart assumes droplets have average sizes  $< 10 \mu\text{m}$

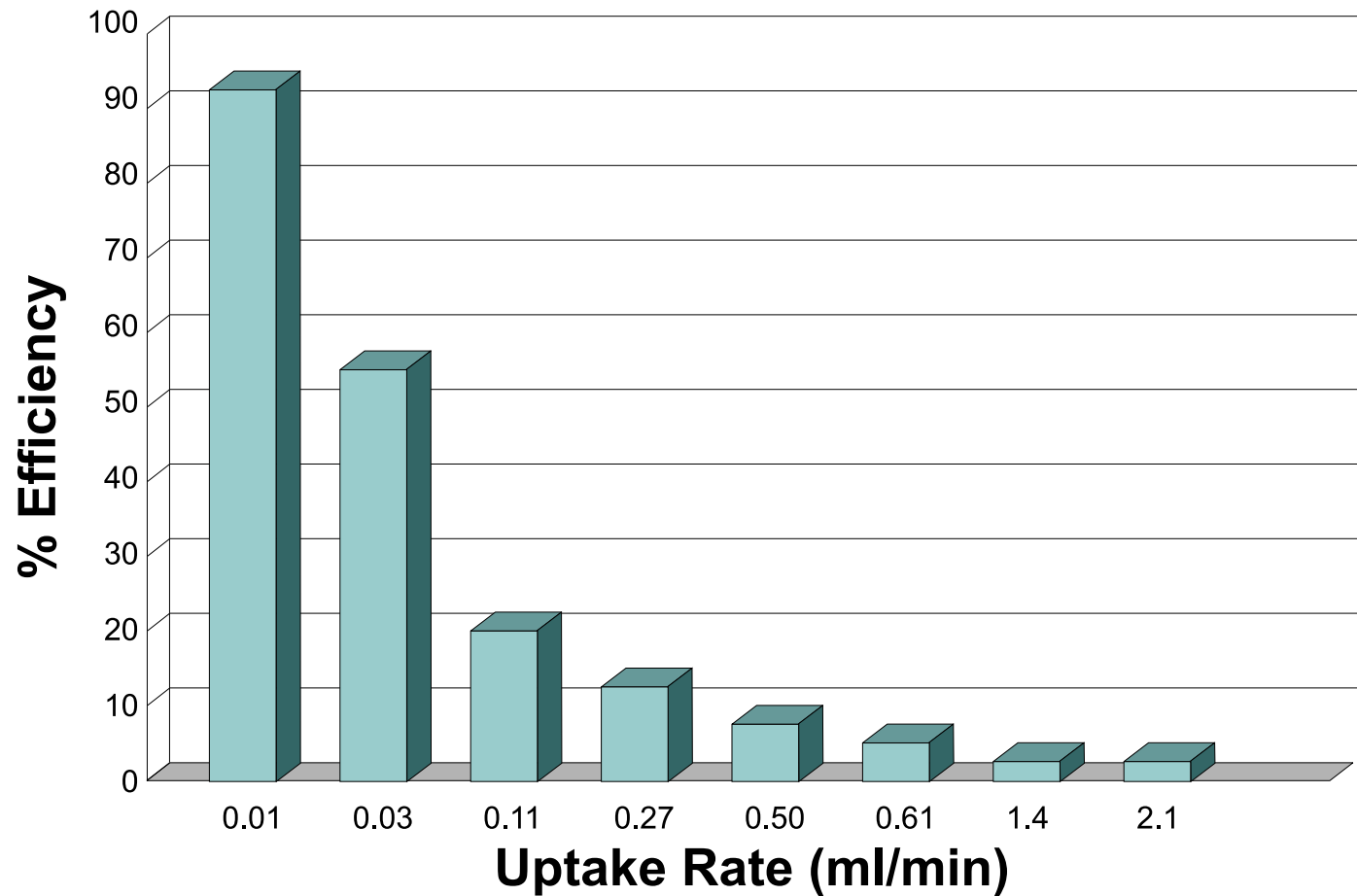

John A. Burgener

 Burgener Research Inc.

Data from Geoff Coleman, Meinhard

# Disadvantages of Micro Nebulizers?

**Micro Concentrics usually have micro capillaries.**

**Micro particles can plug them.**

**Micro salts can plug them.**

**Micro damage can break them.**

# Advantages of Dry Samples

**Torches can handle 40 - 60  $\mu\text{l}/\text{min}$  of sample**

The variation probably relates to how much sample has vaporized.

**With Desolvation, Heating, Cooling,  
some of the water can be removed.**

**With the sample all vaporized,  
one gains the same benefits of low flow.**

**With High Efficiency Nebulizers, TOO MUCH sample  
will arrive at the torch unless water is removed.**

**More than 40-60  $\mu\text{l}/\text{min}$  water will quench / kill the plasma.**

**If you can dry 1 ml/min, the signal is 25X better than 40  $\mu\text{l}/\text{min}$ .**

# Since 1988 Cetac Ultrasonic Nebulizers have used Desolvators

Efficiency approaches 30%, Sensitivity improves ~10x  
Droplet size < 5 microns.  
Potentially heavy solvent load so Desolvation essential.  
Peltier cooling essential.  
Membrane separator available and usually essential.  
Desolvation interferences occur (eg., As III vs. As IV)

Does not handle high solids well.  
Long washout times required due to desolvators.

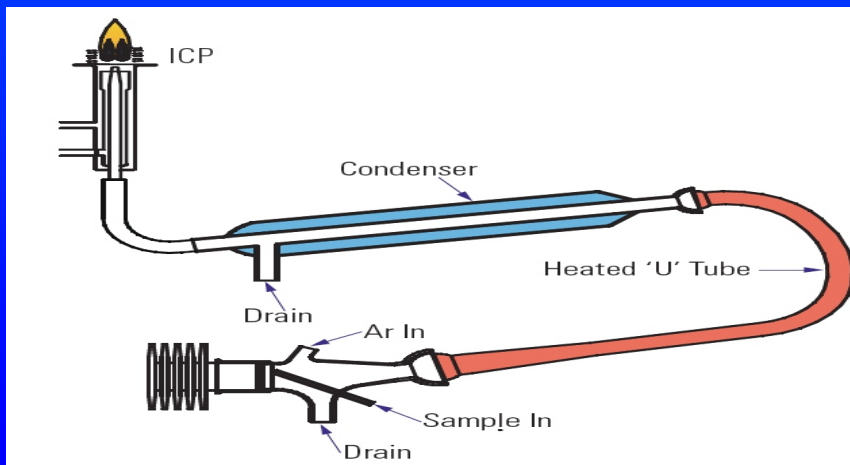

Evaluation of an Ultrasonic Nebulizer Using Perkin-Elmer Sequential ICP Instrumentation - Robert Thomas, Cindy Anderau - Atomic Spectroscopy, 10 (2), 71 (1989). This paper describes the capabilities of the first commercially available ultrasonic nebulizer, the CETAC USN-5000 with two of Perkin Elmer's ICP optical emission spectrometers, the Plasma 40 and Plasma II. Various criteria were evaluated including detection limit, precision and memory test. The conclusion of the work was that the early design of this product showed great promise but required some improvements to be accepted and used as a truly routine analytical tool.

# Desolvation Accessories

Now available for most nebulizers, not just Ultra Sonic

**Sensitivity improves ~10x**  
**Uses any 6 mm nebulizer**  
**and cyclonic spray chamber**

**Desolvation interferences problematic**  
**High solids still problematic**

**Available in HF-resistant versions**  
**Available with membrane desolvation**

**Aridus II from CETAC**  
**Apex from Elemental Scientific**



John A. Burgener

 Burgener Research Inc.



# Spray Chamber Temperature Control

**Sensitivity improves**  
**Uses any 6 mm nebulizer**  
**and cyclonic spray chamber**

**Reduces solvent loading**  
**Reduces oxide interferences in ICP/MS**

**Available in HF-resistant versions**

**PC3 from Elemental Scientific**  
**IsoMist from Glass Expansion**



John A. Burgener

 Burgener Research Inc.

# Disadvantages of Micro Nebulizers?

**Micro Concentrics usually have micro capillaries.**

**Micro particles can plug them.**

**Micro salts can plug them.**

**Micro damage can break them.**

**Micro Flow takes Macro time**

**to get from sample to nebulizer.**

# Flow Injection

Allows rapid sample turnaround for micro flows.

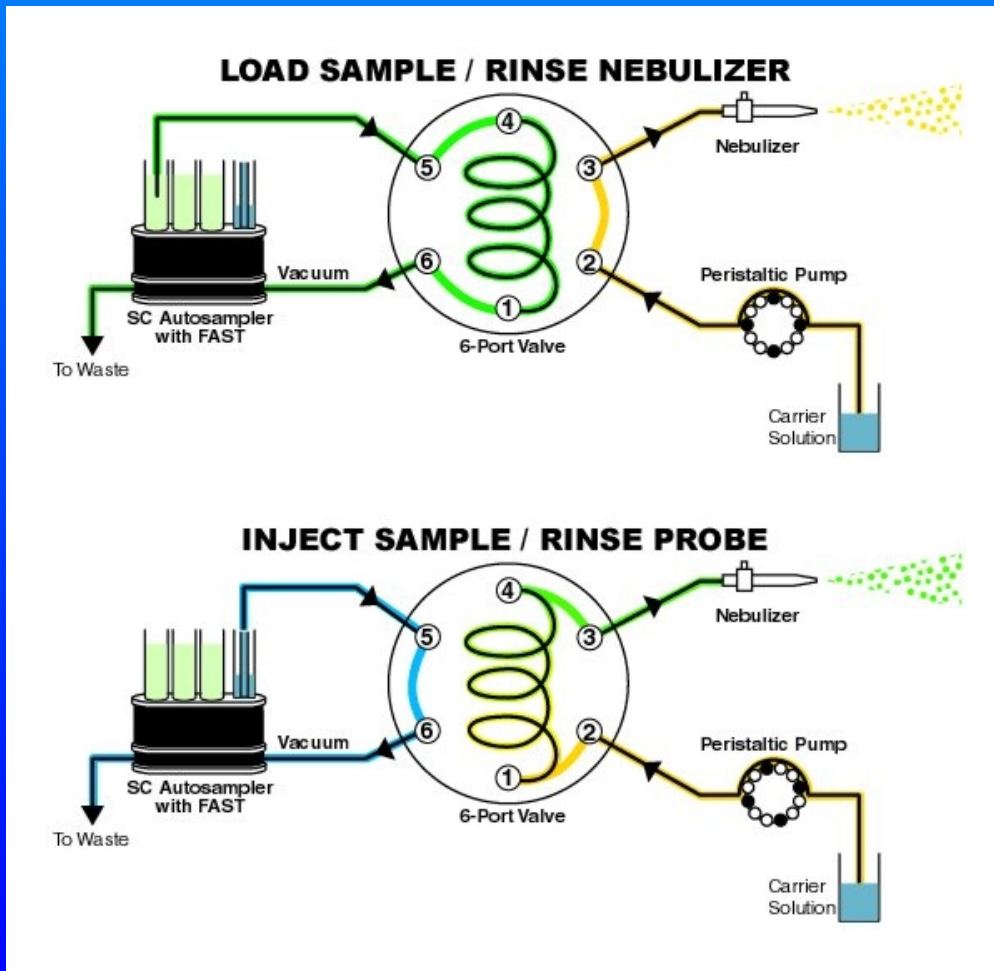

Low liquid flow rates mean very low sample throughput

Flow injection / fast rinse  
Makes low flow practical.  
Sample is quickly sucked up by vacuum, then slowly sent to nebulizer.

John A. Burgener

 Burgener Research Inc.

Available from CETAC, ESI, GE

# Split Flow

Allows rapid sample turnaround for micro flows.

**ENYA MIST - 0.2 to 50  $\mu\text{l}/\text{min}$**   
**SPLIT FLOW CAPABILITY**

**Input 500  $\mu\text{l}/\text{min}$**

**Max flow of 50  $\mu\text{l}/\text{min}$**   
**Desired flow 10  $\mu\text{l}/\text{min}$**

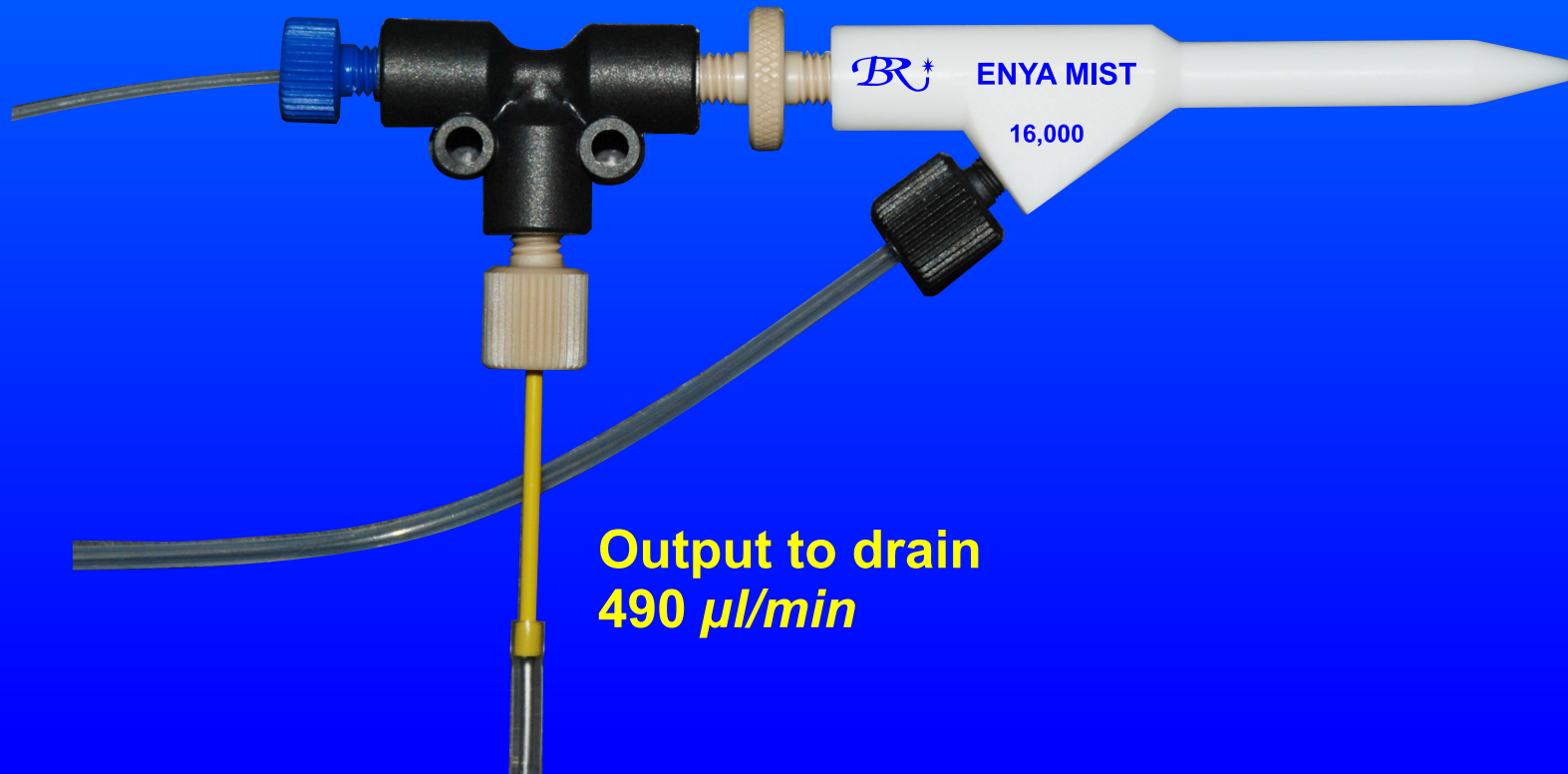

**Output to drain**  
**490  $\mu\text{l}/\text{min}$**

# ENYA MIST - 0.2 to 50 $\mu\text{l}/\text{min}$

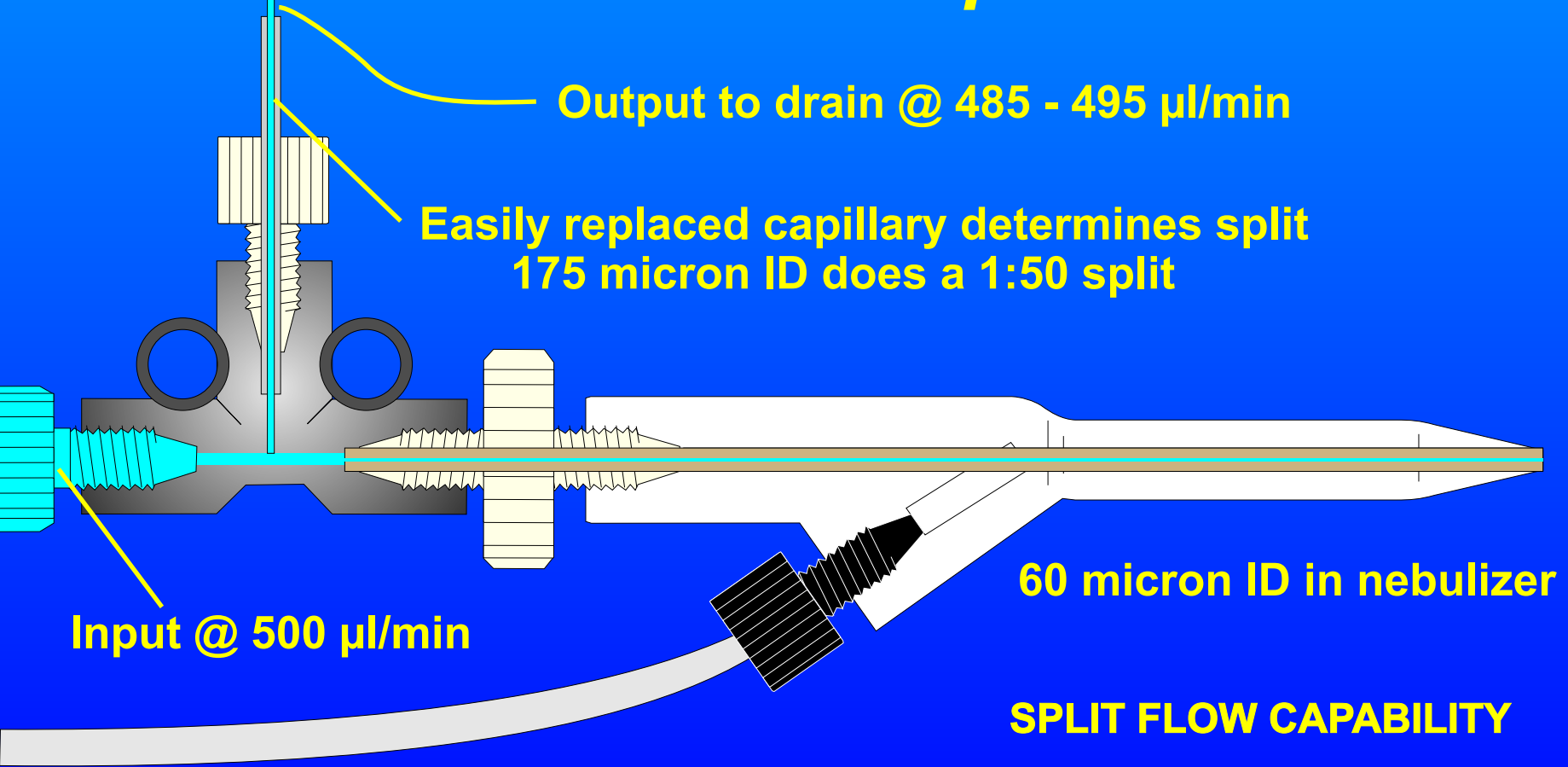

Similar configuration to  
Mira Mist CE

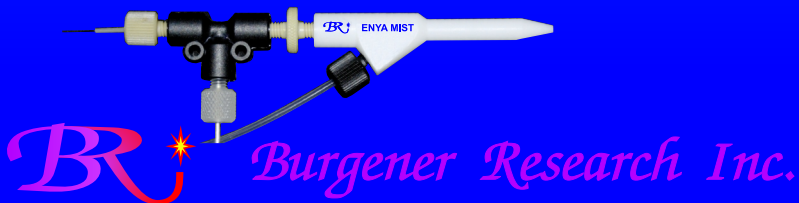



**Enya Mist with  
PE Elan 9000  
ESI Cooled cyclonic**

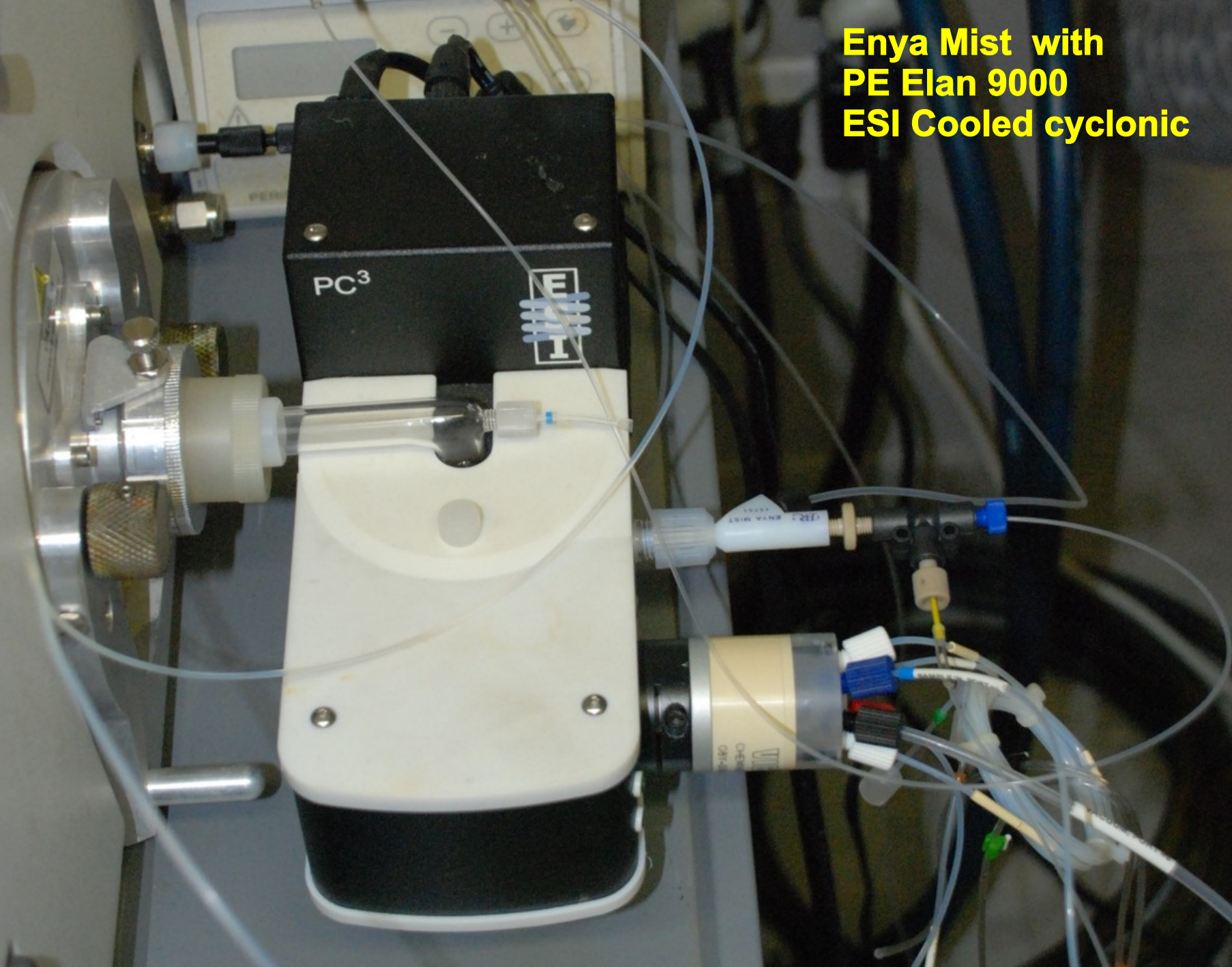

# Disadvantages of Micro Nebulizers?

**Micro Concentrics usually have micro capillaries.**

**Micro particles can plug them.**

**Micro salts can plug them.**

**Micro damage can break them.**

**Micro Flow takes Macro time**

**to get from sample to nebulizer.**

**Long narrow capillaries cause signal broadening**

**when connected to LC / CE**

# LC, HPLC Connections

readily available from most manufacturers

Mira Mist LC interface



Meinhard and ESI standard fittings attach to LC



Glass Expansion LC interface

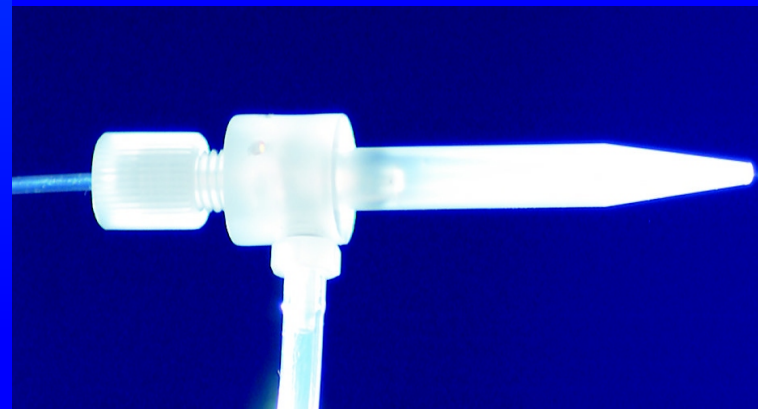
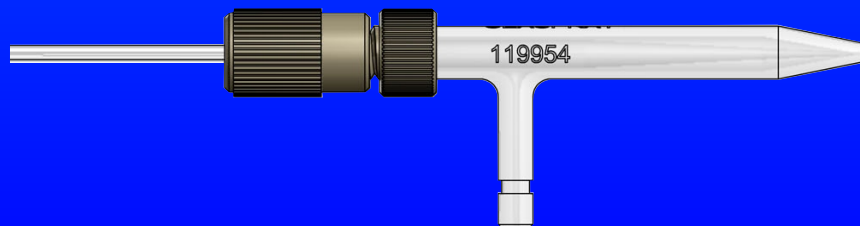

John A. Burgener

 Burgener Research Inc.



# Signal Broadening Problem

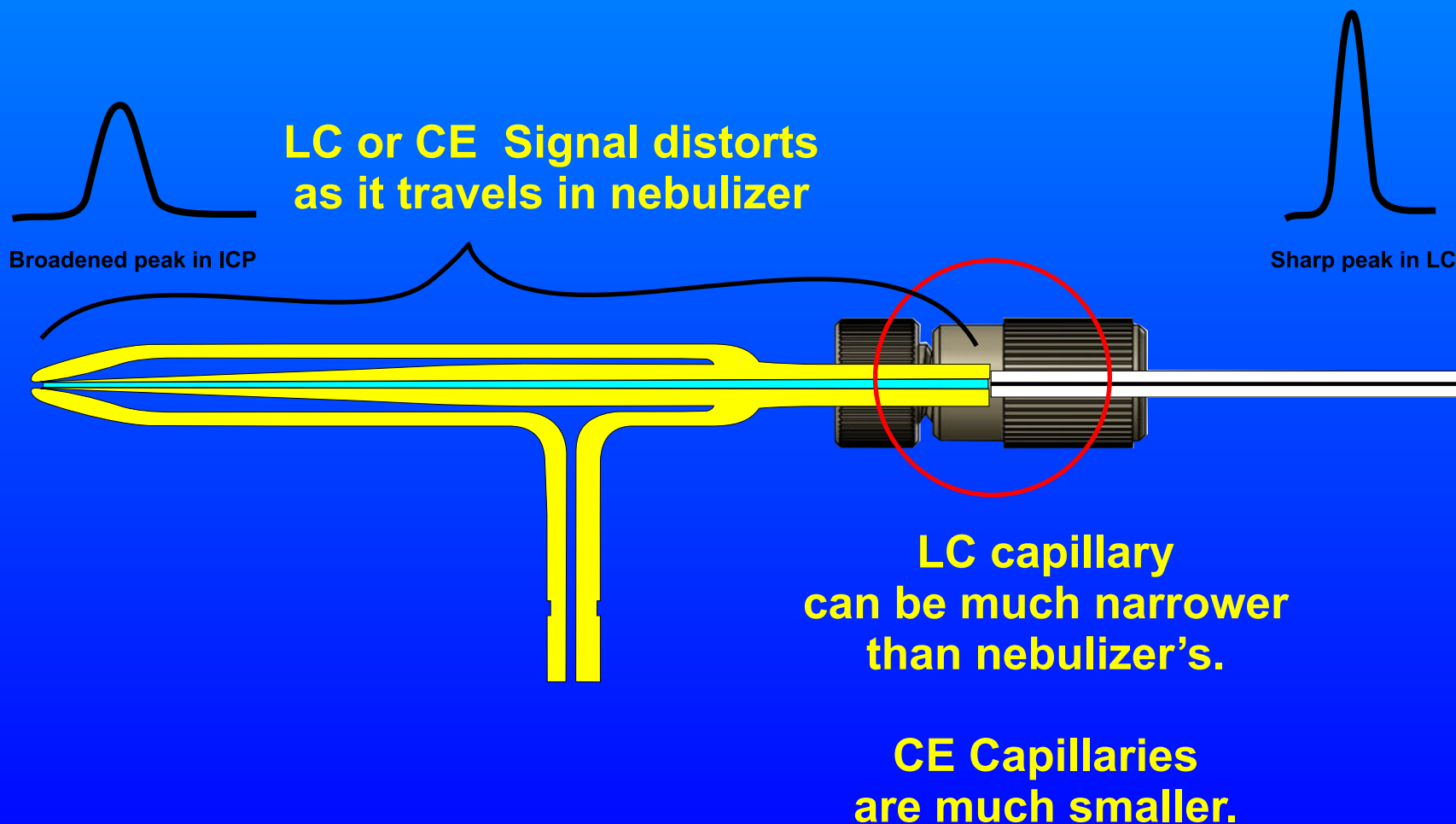

John A. Burgener

 Burgener Research Inc.

# CE Interfaces

## Only available from Burgener and Cetac

### Mira Mist CE interface

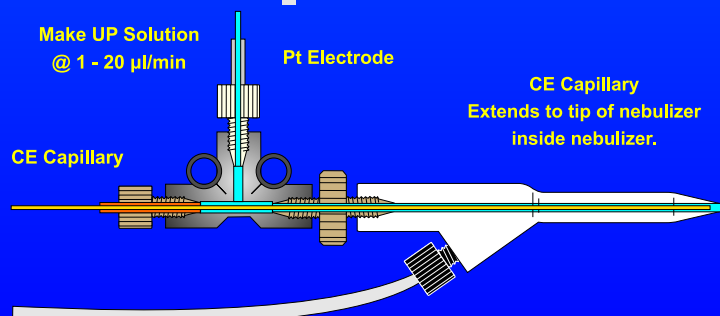
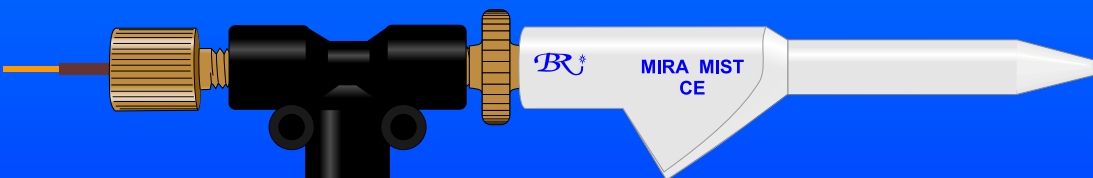

CE Capillary extends to tip: No signal broadening

John A. Burgener

 Burgener Research Inc.

### Cetac CEI 100

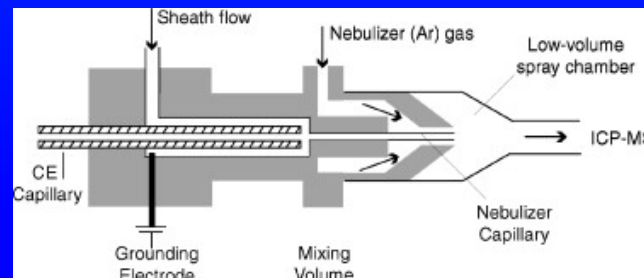

Short length micro concentric: minimal signal broadening

***Mira Mist CE: Interface for ICP/MS, CE & LC***  
***Convenient Nano Sample Introduction***  
***2  $\mu\text{l}/\text{min}$  to 2,500  $\mu\text{l}/\text{min}$***



**ICP/MS Interface for CE and LC**  
**0.002 to 2.5 ml/min sample flow rates.**  
**80+ psi for 1 L/min**

# Ideal Nebulizer for CE and LC interfacing to ICP/MS

The CE or LC capillary runs through the nebulizer body to the tip, enabling “instant” flow from the CE/LC capillary to the gas stream. There is no loss of signal as there is with nebulizers interfacing at the back of the nebulizer. The Mira Mist CE has zero suction or back pressure, so there is no interference with the flow from the CE or LC, just 100% transfer, instantly.

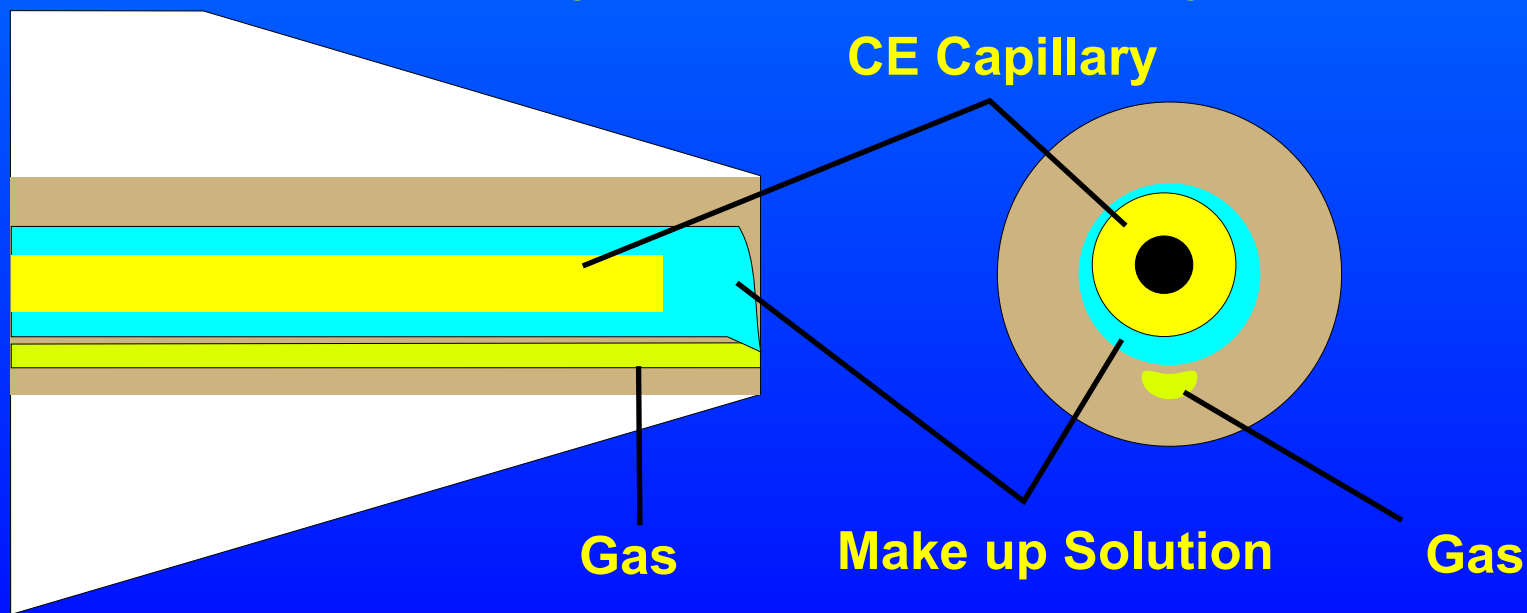

Detail of tip of Mira Mist CE

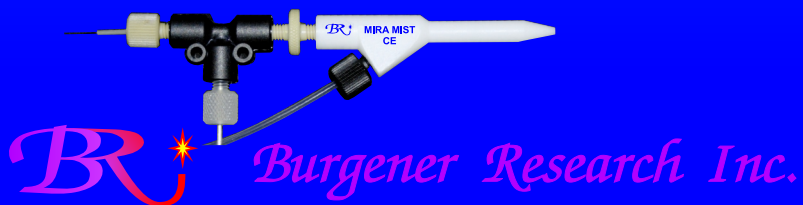

# Mira Mist CE

## A workable Routine CE - ICP/MS interface and Nano Sample Introduction Method

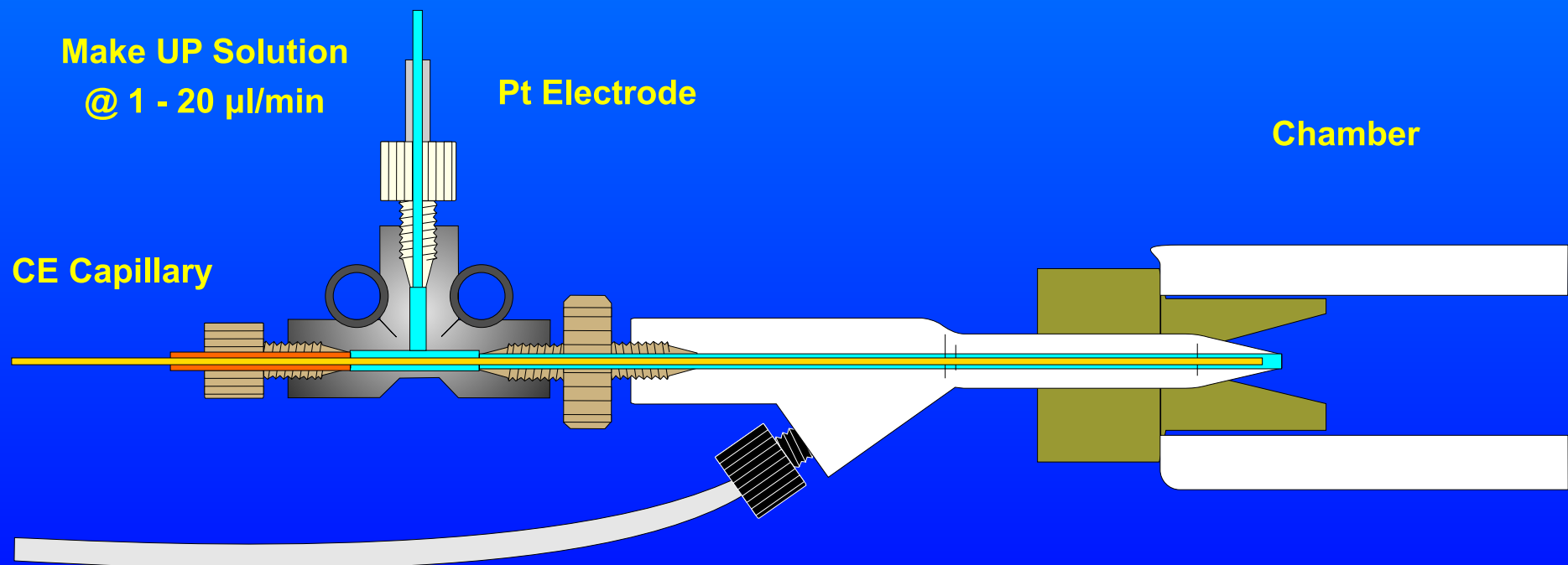

# ***Atomization is independent of sample flow.***

***As long as the make up solution covers the CE capillary, it maintains good electrical contact and the CE sample is washed directly to the gas orifice.***

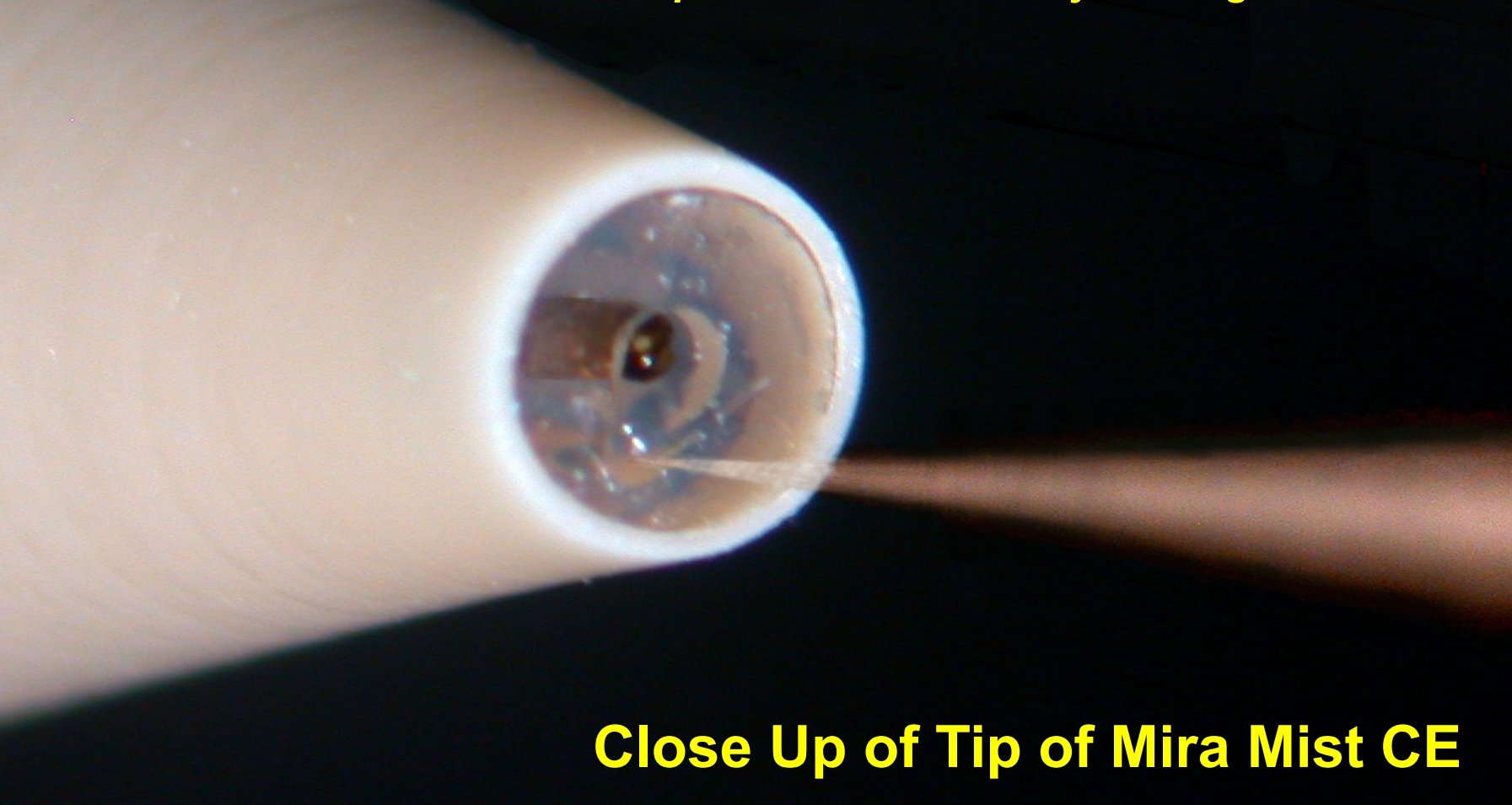

***Close Up of Tip of Mira Mist CE***



**Enhanced  
Parallel Path  
Method  
with  
CE  
Capillary**

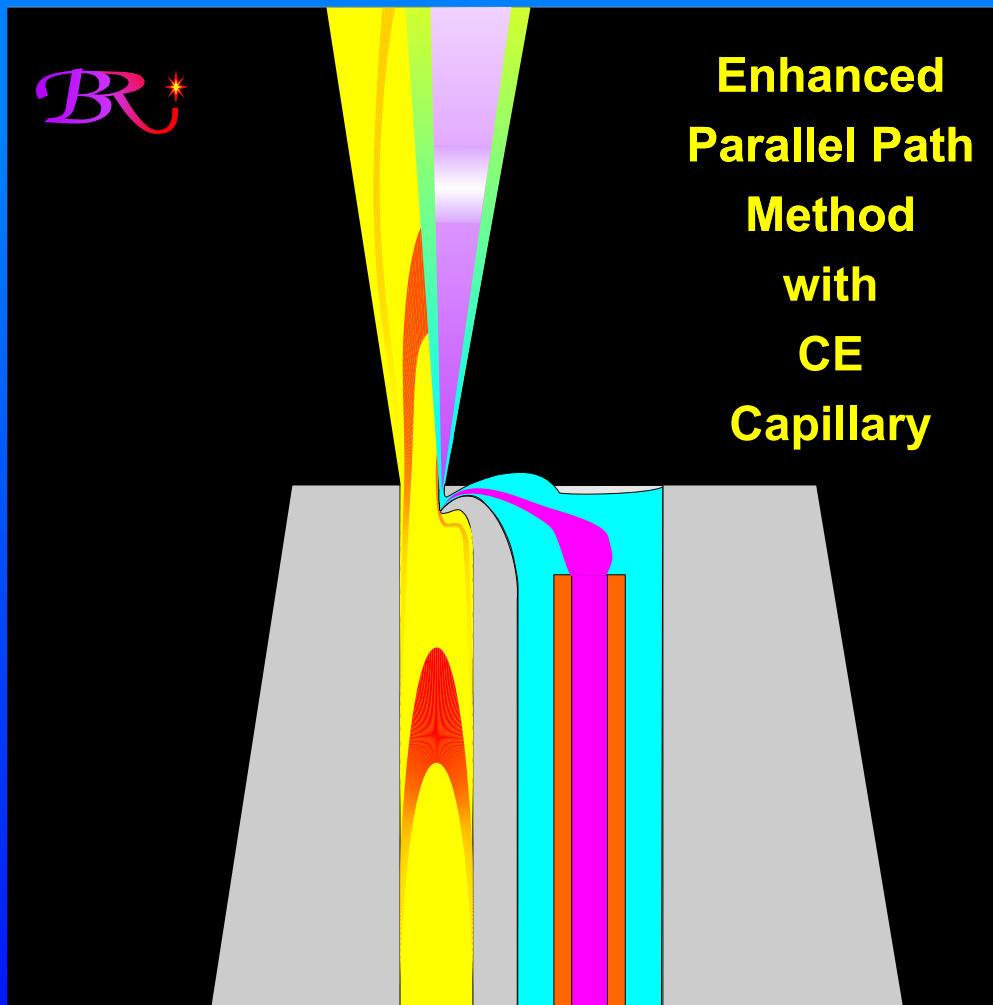

# Other approach to $\mu$ HPLC interfacing

**Signal broadening occurs when  
the sample passes from a tiny capillary  
into a wider capillary**

**Solution: Make a nebulizer with a similar size capillary.**



# The ENYA MIST: 60 $\mu\text{m}$ ID

ENYA = Irish name meaning “Little Fire”.  
The Enya Mist is designed to send  
very little mist into the plasma (fire).



200 nl to 50  $\mu\text{l}/\text{min}$  Micro Flow Nebulizer  
For nano HPLC interfacing  
And for Split Flow applications

# Standard sizes of micro-HPLC columns

(From G & T Septeck)

Column ID (mm)	Column Category	Flow Rate Range ( $\mu\text{L}/\text{min}$ )	Optimum Flow Rate ( $\mu\text{L}/\text{min}$ )	Analyte Capacity	Bed volume 15 cm column ( $\mu\text{L}$ )
1.0	microbore	20 - 200	35	$\sim 10 \mu\text{g}$	120
0.5	capillary	5 - 50	8	$\sim 2.5 \mu\text{g}$	30
0.3	capillary	2 - 20	3	$\sim 1 \mu\text{g}$	10
0.1	nano	0.25 - 2.5	0.5	$\sim 100 \text{ ng}$	2
0.075	nano	0.1 - 1	0.3	$\sim 25 \text{ ng}$	0.7

All micro and nano HPLC flow ranges covered by Enya Mist

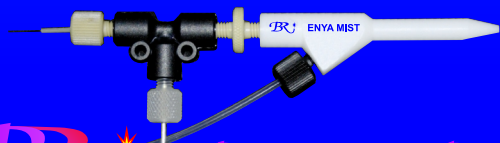



# What's New in Nebulizers

## PART 4: New 2013 nebulizers from Burgener The End is very near.

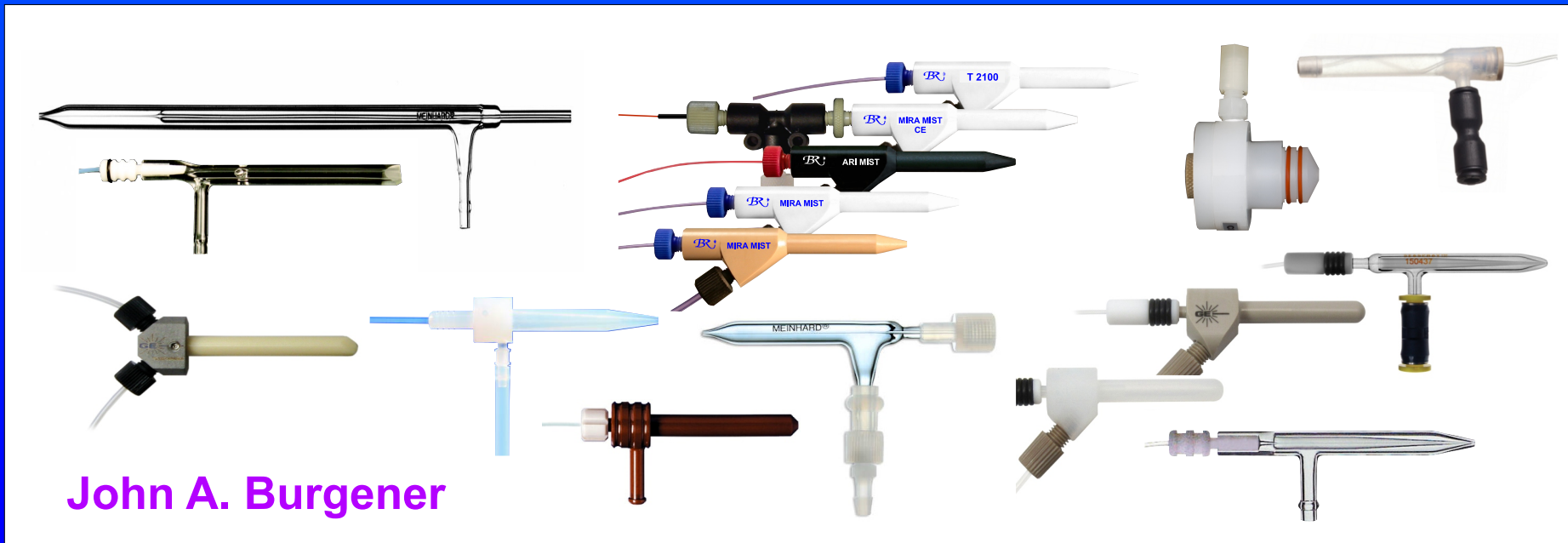

# The newest Burgener Nebulizers (2013)

## The X 175

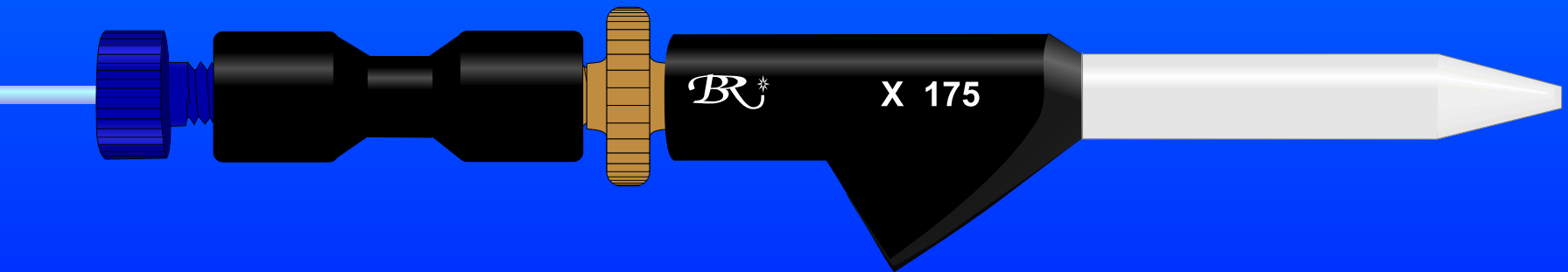

Made in the same style as the Mira Mist CE  
Greater stability at low flows than the Ari Mist

Wetted surfaces are Peek or PTFE  
The body is strong PEEK.

Runs from 50  $\mu$ l/min to 1 ml/min  
175 micron sample line ID.

# The newest Burgener Nebulizers (2013)

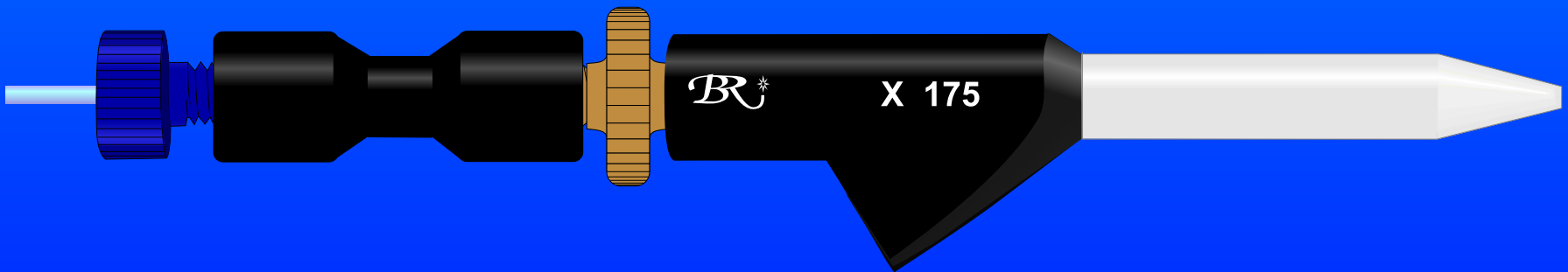

The X series can be made in any size internal capillary,  
from 60 - 760 micron ID

Which matches the main product line Enya Mist to T2100  
But runs at higher gas pressures, lower gas flows, and greater stability.

They are expected to mainly be made  
in the Ari Mist range of 100 - 250 micron ID.

# The newest Burgener Nebulizers (2013)

## The PFA 250



**All wetted surfaces are PFA.  
The body is strong PEEK.**

**Runs from 50  $\mu$ l/min to 1.5 ml/min  
250 micron sample line ID**

# The newest Burgener Nebulizers (2013)

## The PFA 250

1/16" PFA capillary  
extends to the  
tip of the nebulizer

All PFA in chamber



All wetted surfaces are PFA.  
The body is strong PEEK.

Runs from 50  $\mu$ l/min to 1.5 ml/min  
250 micron sample line ID

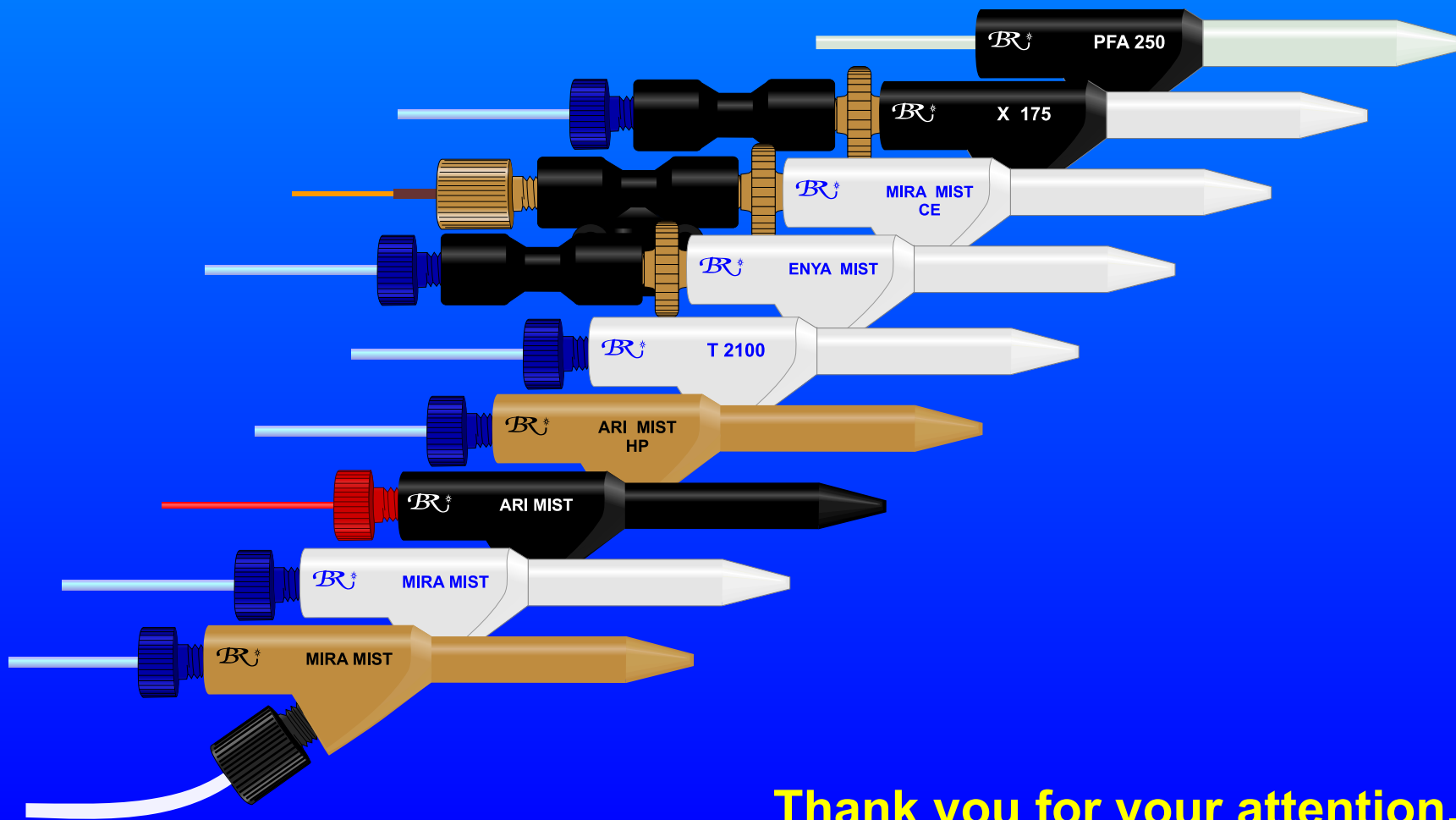

**Thank you for your attention.**